



ETA-Danmark A/S
Göteborg Plads 1
DK-2150 Nordhavn
Tel. +45 72 24 59 00
Fax +45 72 24 59 04
Internet www.etadanmark.dk

Authorised and notified according
to Article 29 of the Regulation (EU)
No 305/2011 of the European Par-
liament and of the Council of 9
March 2011

MEMBER OF EOTA



European Technical Assessment ETA-11/0030 of 2020/12/10

I General Part

Technical Assessment Body issuing the ETA and designated according to Article 29 of the Regulation (EU) No 305/2011: ETA-Danmark A/S

Trade name of the construction product:

Rotho Blaas Self-tapping screws and threaded rods

Product family to which the above construction product belongs:

Screws and threaded rods for use in timber constructions

Manufacturer:

Rotho Blaas s.r.l
Via dell'Adige 2/1
IT-38040 Cortaccia (BZ)
Tel. + 39 0471 818400
Fax + 39 0471 818484
Internet www.rothoblaas.com

Manufacturing plant:

Rotho Blaas s.r.l. - Held on file by ETA-Danmark AS

This European Technical Assessment contains:

72 pages including 7 annexes which form an integral part of the document

This European Technical Assessment is issued in accordance with Regulation (EU) No 305/2011, on the basis of:

European Assessment document (EAD) no. EAD 130118-01-0603 "Screws and threaded rods for timber constructions"

This version replaces:

The previous ETA with the same number issued on 2019-10-08

Translations of this European Technical Assessment in other languages shall fully correspond to the original issued document and should be identified as such.

Communication of this European Technical Assessment, including transmission by electronic means, shall be in full (excepted the confidential Annex(es) referred to above). However, partial reproduction may be made, with the written consent of the issuing Technical Assessment Body. Any partial reproduction has to be identified as such.

II SPECIFIC PART OF THE EUROPEAN TECHNICAL ASSESSMENT

1 Technical description of product

Technical description of the product

Rotho Blaas “HBS”, “HBSP”, “TBS”, “KKF”, “SCI”, “VGS”, “VGZ”, “DGZ”, “KKT”, “HBSH”, “VGZH”, “VGSH” and “LBS” screws and “RTR” threaded rods are self-tapping screws to be used in timber structures. “HBS” screws are also called “SCH”, “GHS” “SNK” or “SHS” screws, “HBSP” screws are also called “GHS+” or “KGL” screws, “KKF” screws are also called „GHKF”, “KGA” or screws and “TBS” screws are also called “GHSK”, “TLL” or screws, “VGS” screws are also called “GWS” screws, “VGZ” screws are also called “GWZ” screws, “KKT” screws are also called “MN” screws. Rotho Blaas “HBS”, “HBSP”, “TBS”, “KKF”, “HBSH” and “SCI” screws shall be threaded over a part of the length. Rotho Blaas “VGS”, “VGZ”, “VGZH”, “VGSH” and “LBS” screws and “RTR” threaded rods shall be threaded over the full length. Rotho Blaas “DGZ” and “KKT” screws shall have two threaded parts over the length. The screws shall be produced from carbon steel wire for nominal diameters of 3,0 mm to 13,0 mm and from stainless steel wire for nominal diameters of 3,5 mm to 8,0 mm. The nominal diameter of “RTR” threaded rods is 16 mm or 20 mm. Rotho Blaas "VGU" washers are used for VGS self-tapping screws in timber structures. The washers shall be produced from carbon or stainless steel. Where corrosion protection is required, the material or coating shall be declared in accordance with the relevant specification given in Annex A of EN 14592.

Geometry and Material

The nominal diameter (outer thread diameter), d , shall not be less than 3,0 mm and shall not be greater than 20,0 mm. The overall length, L , of screws shall not be less than 20 mm and shall not be greater than 1200 mm. The overall length of the threaded rods shall not be greater than 3000 mm. Other dimensions are given in Annex A.

Screw types “HBS”, “SCH”, “GHS”, “SNK”, “SHS”, “HBSP”, “GHS+”, “KGL”, “TBS”, „GHSK”, “TLL”, “DGZ”, “LBS”, “VGS”, “GWS”, “VGZ”, “GWZ” and “HBSH”, “VGZH”, “VGSH” and “RTR” threaded rods are made from carbon steel.

Screw types “KKF” and “GHKF” are made from martensitic stainless steel 1.4006 and SCI are made from stainless steel grade 1.4401 or 1.4567.

Screw types “KKT” are made from either carbon steel or stainless steel.

The ratio of inner thread diameter to outer thread diameter d_1/d ranges from 0,55 to 0,75.

The screws are threaded over a minimum length ℓ_g of $4,0 \cdot d$ (i.e. $\ell_g \geq 4,0 \cdot d$).

The lead p (distance between two adjacent thread flanks) ranges from $0,35 \cdot d$ to $0,76 \cdot d$.

No breaking shall be observed at a bend angle, α , of less than $(45/d^{0.7} + 20)$ degrees.

2 Specification of the intended use in accordance with the applicable European Assessment Document (hereinafter EAD)

The screws are used for connections in load bearing timber structures between members of solid timber, glued laminated timber, cross-laminated timber, and laminated veneer lumber (softwood and hardwood), similar glued members, wood-based panels or steel. The threaded rods are used for connections in load bearing timber structures between softwood members of solid timber, glued laminated timber, cross-laminated timber and laminated veneer lumber or similar glued members.

Rotho Blaas “VGS”, “VGZ”, “VGZH” and “VGSH” screws and “RTR” threaded rods are also used as tensile, compressive reinforcement perpendicular to the grain or shear reinforcement. Furthermore, Rotho Blaas screws with diameters between 6 mm and 12 mm may also be used for the fixing of thermal insulation material on rafters and on vertical facades.

Steel plates and wood-based panels except solid wood panels and cross laminated timber shall only be located on the side of the screw head. The following wood-based panels may be used:

- Plywood according to EN 636 or or ETA
- Particleboard according to EN 312 or or ETA
- Oriented Strand Board, Type OSB/3 and OSB/4 according to EN 300 or ETA
- Fibreboard according to EN 622-2 and 622-3 or ETA (minimum density 650 kg/m³) or national provisions that apply at the installation site
- Cement bonded particleboard according to EN 634 or ETA
- Solid wood panels according to EN 13353 and EN 13986 and cross laminated timber according to ETA
- Laminated Veneer Lumber according to EN 14374 or European Technical Approval
- FST according to ETA-14/0354
- Engineered wood products according to ETA, provided that the ETA for the product provides provisions for the use of self-tapping screws and these provisions are applied

The screws shall be driven into the wood without pre-drilling or after pre-drilling. The threaded rods shall be driven into softwood after pre-drilling

The screws or threaded rods are intended to be used in timber connections for which requirements for mechanical resistance and stability and safety in use in the sense of the Basic Works Requirements 1 and 4 of Regulation 305/2011 (EU) shall be fulfilled.

The design of the connections shall be based on the characteristic load-carrying capacities of the screws or threaded rods. The design capacities shall be derived from the characteristic capacities in accordance with Eurocode 5 or an appropriate national code (e.g. DIN 1052:2008-12).

The screws or threaded rods are intended for use for connections subject to static or quasi static loading.

Section 3.11 of this ETA contains the corrosion protection for Rotho Blaas screws or threaded rods made from carbon steel and the material number of the stainless steel. The screws are for use in timber structures subject to service classes 1, 2 and 3 of Eurocode 5. In service class 1 and 2 the corrosion protection is given according to EN1995-1-1, or by equivalent measures. In service class 3 the corrosion protection is given according to EN1995-1-1 or by stainless steel. Alternatively, a Zn-Al flakes coating (also called "evo coating") can be used as corrosion protection in service class 3."

The scope of the screws or threaded rods regarding resistance to corrosion shall be defined according to national provisions that apply at the installation site considering environmental conditions.

The provisions made in this European Technical Assessment are based on an assumed intended working life of the screws of 50 years.

The indications given on the working life cannot be interpreted as a guarantee given by the producer or Assessment Body, but are to be regarded only as a means for choosing the right products in relation to the expected economically reasonable working life of the works.

3 Performance of the product and references to the methods used for its assessment

Characteristic	Assessment of characteristic
3.1 Mechanical resistance and stability*) (BWR1)	
Tensile strength	Characteristic value $f_{\text{tens,k}}$:
Screw made from carbon steel “HBS”, “SCH”, “GHS”, “SNK”, “SHS”, “HBSP”, “GHS+”, “KGL”, “TBS”, “GHSK”, “TLL”, “DGZ”, “LBS”, “VGS”, “GWS”, “VGZ”, “GWZ”, “KKT”, “MN” and screws made from stainless steel “KKF” and “GHKF”	Screw d = 3,0 mm: 2,8 kN
	Screw d = 3,5 mm: 3,8 kN
	Screw d = 4,0 mm: 5,0 kN
	Screw d = 4,5 mm: 6,4 kN
	Screw d = 5,0 mm: 7,9 kN
	Screw d = 5,3 mm: 11,0 kN
	Screw d = 5,6 mm: 12,3 kN
	Screw d = 6,0 mm: 11,3 kN
	Screw d = 7,0 mm: 15,4 kN
	Screw d = 8,0 mm: 20,1 kN
	Screw d = 9,0 mm: 25,4 kN
	Screw d = 10,0 mm: 31,4 kN
	Screw d = 11,0 mm: 38,0 kN
	Screw d = 12,0 mm: 33,9 kN
	Screw d = 13,0 mm: 53,0 kN
Screws made from carbon steel “HBSH”, “VGZH”, “VGSH”	Screw d = 6,0 mm: 18 kN
	Screw d = 8,0 mm: 32 kN
Threaded rods made from carbon steel “RTR”	Rod d = 16,0 mm: 100 kN
	Rod d = 20,0 mm: 145 kN
Screws made from stainless steel “KKT”, “MN” and “SCI”	Screw d = 3,5 mm: 2,1 kN
	Screw d = 4,0 mm: 2,8 kN
	Screw d = 4,5 mm: 3,5 kN
	Screw d = 5,0 mm: 4,3 kN
	Screw d = 6,0 mm: 6,2 kN
Screw d = 8,0 mm: 11,1 kN	
Insertion moment	Ratio of the characteristic torsional strength to the mean insertion moment: $f_{\text{tor,k}} / R_{\text{tor,mean}} \geq 1,5$
Torsional strength	Characteristic value $f_{\text{tor,k}}$:
Screw made from carbon steel “HBS”, “SCH”, “GHS”, “HTP”, “SNK”, “HBSP”, “GHS+”, “KGL”, “TBS”, “GHSK”, “TLL”, “DGZ”, “LBS”, “VGS”, “GWS”, “VGZ”, “GWZ”, “KKT”, “MN” and screws made from stainless steel “KKF” and “GHKF”	Screw d = 3,0 mm: 1,3 Nm
	Screw d = 3,5 mm: 2,0 Nm
	Screw d = 4,0 mm: 3,0 Nm
	Screw d = 4,5 mm and LBS
	screw d = 5,0 mm: 5,0 Nm
	Screw d = 5,0 mm (except LBS): 7,5 Nm
	Screw d = 5,3 mm: 9,0 Nm
	Screw d = 5,6 mm: 10,0 Nm
	Screw d = 6,0 mm: 12,0 Nm
	Screw d = 7,0 mm: 18,0 Nm
	Screw d = 8,0 mm: 28,0 Nm
	Screw d = 9,0 mm: 36,0 Nm
	Screw d = 10,0 mm: 40,0 Nm
	Screw d = 11,0 mm: 61,0 Nm
	Screw d = 12,0 mm: 60,0 Nm
Screw d = 13,0 mm: 95,0 Nm	

Characteristic	Assessment of characteristic
Screws made from carbon steel “HBSH”, “VGZH”, “VGSB”	Screw d = 6,0 mm: 18,0 Nm Screw d = 8,0 mm: 38,0 Nm
Threaded rods made from carbon steel “RTR”	Screw d = 16,0 mm: 300 Nm Screw d = 20,0 mm: 500 Nm
Screws made from stainless steel “KKT”, “MN” and “SCI”	Screw d = 3,5 mm: 1,5 Nm Screw d = 4,0 mm: 2,0 Nm Screw d = 4,5 mm: 3,0 Nm Screw d = 5,0 mm: 5,0 Nm Screw d = 6,0 mm: 8,0 Nm Screw d = 8,0 mm: 18,0 Nm
3.2 Safety in case of fire (BWR2)	
Reaction to fire	The screws are made from steel classified as class A1 in accordance with EN 13501-1 and Commission Delegated Regulation 2016/364.
3.8 General aspects related to the performance of the product	The screws have been assessed as having satisfactory durability and serviceability when used in timber structures using the timber species described in Eurocode 5 and subject to the conditions defined by service classes 1, 2 and 3

*) See additional information in section 3.9 – 3.12.

3.9 Mechanical resistance and stability

The load-carrying capacities for Rotho Blaas screws or threaded rods are applicable to the wood-based materials mentioned in paragraph 1 even though the term timber has been used in the following.

The characteristic lateral load-carrying capacities and the characteristic axial withdrawal capacities of Rotho Blaas screws and threaded rods should be used for designs in accordance with Eurocode 5 or an appropriate national code.

Point side penetration length must be $l_{ef} \geq 4 \cdot d$, where d is the outer thread diameter of the screw or threaded rod. For the fixing of rafters, point side penetration must be at least 40 mm, $l_{ef} \geq 40$ mm.

Point or head side penetration thread length for screws made of carbon steel driven without pre-drilling in Beech LVL according to EN 14374 or in FST according to ETA-14/0354 must not exceed the following values:

HBSH screw $d = 6,0$ mm: $l_{ef} \leq 90$ mm

HBSH screw $d = 8,0$ mm: $l_{ef} \leq 100$ mm

Accumulated point and head side penetration length for threaded rods must not exceed 2200 mm.

Screws made of carbon steel except “KKT” or “HBSH”, “VGZH”, “VGSH” shall be driven in pre-drilled holes if the characteristic member density exceeds 550 kg/m^3 .

Screws made of stainless steel shall be driven in pre-drilled holes if the characteristic member density exceeds 500 kg/m^3 .

European Technical Assessments for structural members or wood-based panels must be considered where applicable.

Reductions in the cross-sectional area caused by Rotho Blaas screws or threaded rods with a diameter of 10 mm or more shall be taken into account in the member strength verification both, in the tensile and compressive area of members.

For screws or threaded rods in pre-drilled holes, the drill hole diameter should be considered in the member strength verification, for screws driven without pre-drilling, the inner thread diameter.

For wood-based panels the relevant ETA's must be considered where applicable.

Lateral load-carrying capacity

The characteristic lateral load-carrying capacity of Rotho Blaas screws or threaded rods shall be calculated according to EN 1995-1-1:2008 (Eurocode 5) using the outer thread diameter d as the effective diameter of the screw.

For steel-to-timber connections with screws LBS $d = 5$ mm, a thick steel plate may be assumed for steel plate thickness $t \geq 1,5$ mm.

The characteristic yield moment is:

Rotho Blaas screws or threaded rods made from carbon steel except “HBSH”, “VGZH”, “VGSH” and “KKF” and “GHKF” screws made from stainless steel:

Screw $d = 3,0$ mm:	$M_{y,k} = 1,4$ Nm
Screw $d = 3,5$ mm:	$M_{y,k} = 2,1$ Nm
Screw $d = 4,0$ mm:	$M_{y,k} = 3,0$ Nm
Screw $d = 4,5$ mm:	$M_{y,k} = 4,1$ Nm
Screw $d = 5,0$ mm:	$M_{y,k} = 5,4$ Nm
Screw $d = 5,3$ mm:	$M_{y,k} = 9,2$ Nm
Screw $d = 5,6$ mm:	$M_{y,k} = 10,6$ Nm
Screw $d = 6,0$ mm:	$M_{y,k} = 9,5$ Nm
Screw $d = 7,0$ mm:	$M_{y,k} = 14,2$ Nm
Screw $d = 8,0$ mm:	$M_{y,k} = 20,1$ Nm
Screw $d = 9,0$ mm:	$M_{y,k} = 27,2$ Nm
Screw $d = 10,0$ mm:	$M_{y,k} = 35,8$ Nm
Screw $d = 11,0$ mm:	$M_{y,k} = 45,9$ Nm
Screw $d = 12,0$ mm:	$M_{y,k} = 48,0$ Nm
Screw $d = 13,0$ mm:	$M_{y,k} = 70,9$ Nm
Rod $d = 16,0$ mm:	$M_{y,k} = 200$ Nm
Rod $d = 20,0$ mm:	$M_{y,k} = 350$ Nm

Rotho Blaas screws made from carbon steel “HBSH”, “VGZH”, “VGSH”:

Screw $d = 6,0$ mm:	$M_{y,k} = 15,8$ Nm
Screw $d = 8,0$ mm:	$M_{y,k} = 33,4$ Nm

Rotho Blaas screws made from stainless steel “KKT”, “MN” and “SCI”:

Screw $d = 3,5$ mm:	$M_{y,k} = 1,3$ Nm
Screw $d = 4,0$ mm:	$M_{y,k} = 2,0$ Nm
Screw $d = 4,5$ mm:	$M_{y,k} = 2,8$ Nm
Screw $d = 5,0$ mm:	$M_{y,k} = 4,5$ Nm
Screw $d = 6,0$ mm:	$M_{y,k} = 8,2$ Nm
Screw $d = 8,0$ mm:	$M_{y,k} = 15$ Nm

where

d outer thread diameter [mm]

The embedding strength for screws in non-pre-drilled holes in softwood or hardwood arranged at an angle between screw axis and grain direction, $0^\circ \leq \alpha \leq 90^\circ$ is:

$$f_{h,k} = \frac{0,082 \cdot \rho_k \cdot d^{-0,3}}{2,5 \cdot \cos^2 \alpha + \sin^2 \alpha} \quad [\text{N/mm}^2]$$

and accordingly for screws in pre-drilled holes in softwood and hardwoods beech and oak or threaded rods in softwood:

$$f_{h,k} = \frac{0,082 \cdot \rho_k \cdot (1 - 0,01 \cdot d)}{2,5 \cdot \cos^2 \alpha + \sin^2 \alpha} \quad [\text{N/mm}^2]$$

Where

ρ_k characteristic timber density [kg/m^3], with a maximum characteristic density of 590 kg/m^3 ;

d outer thread diameter [mm];

α angle between screw or rod axis and grain direction.

The embedding strengths given above may be applied for screws or threaded rods within single softwood layers in cross laminated timber, if the single layer is considered as a separate softwood member and the minimum spacing, end and edge distances are observed for the single layer. For inner layers, the edge distance perpendicular to the grain may be reduced to $3 \cdot d$.

Alternatively, the embedding strength for screws or threaded rods arranged parallel to the plane of cross laminated timber (layers of softwood), independent of the angle between screw axis and grain direction, $0^\circ \leq \alpha \leq 90^\circ$, may be calculated from:

$$f_{h,k} = 20 \cdot d^{-0,5} \quad [\text{N/mm}^2]$$

unless otherwise specified in the technical specification (ETA or hEN) for the cross laminated timber.

Where

d outer thread diameter [mm]

The embedding strength for screws or threaded rods in the wide face of cross laminated timber should be assumed as for solid timber based on 110 % of the lowest characteristic density of a board layer. If relevant, the angle between force and grain direction of the outer layer should be taken into account.

The direction of the lateral force shall be perpendicular to the screw axis and parallel to the wide face of the cross laminated timber.

The embedding strength for screws in non-pre-drilled holes in softwood LVL arranged at an angle between screw axis and grain direction, $0^\circ \leq \alpha \leq 90^\circ$ is:

$$f_{h,k} = \frac{0,082 \cdot \rho_k \cdot d^{-0,3}}{(2,5 \cdot \cos^2 \alpha + \sin^2 \alpha)(1,5 \cdot \cos^2 \beta + \sin^2 \beta)} \quad [\text{N/mm}^2]$$

and accordingly for screws or threaded rods in pre-drilled holes in softwood LVL:

$$f_{h,k} = \frac{0,082 \cdot \rho_k \cdot (1 - 0,01 \cdot d)}{(2,5 \cdot \cos^2 \alpha + \sin^2 \alpha)(1,5 \cdot \cos^2 \beta + \sin^2 \beta)} \quad [\text{N/mm}^2]$$

Where

ρ_k characteristic timber density [kg/m³];

d outer thread diameter [mm];

α angle between screw axis and grain direction;

β angle between screw axis and the LVL's wide face ($0^\circ \leq \beta \leq 90^\circ$).

The embedding strength for screws in pre-drilled or non-pre-drilled holes in Beech LVL according to EN 14374 or in FST according to ETA-14/0354 is:

$$f_{h,k} = \frac{0,082 \cdot \rho_k \cdot d^{-0,15}}{(2,5 \cdot \cos^2 \alpha + \sin^2 \alpha) \cdot k_\varepsilon \cdot k_\beta} \quad [\text{N/mm}^2]$$

Where

ρ_k characteristic density [kg/m³];

d outer thread diameter [mm];

α angle between screw axis and grain direction, $0^\circ \leq \alpha \leq 90^\circ$;

$$k_\varepsilon = (0,5 + 0,024 \cdot d) \cdot \sin^2 \varepsilon + \cos^2 \varepsilon;$$

ε angle between load and grain direction; $0^\circ \leq \varepsilon \leq 90^\circ$;

$$k_\beta = 1,2 \cdot \cos^2 \beta + \sin^2 \beta;$$

β angle between screw axis and wide face of LVL or FST member, $0^\circ \leq \beta \leq 90^\circ$.

The definition of the angles α , β and ε is given in Annex G.

For laterally loaded screws, the rules for multiple fastener connections in EN 1995-1-1, 8.3.1.1 (8) should be applied. For laterally loaded threaded rods, the rules for multiple fastener connections in EN 1995-1-1, 8.5.1.1 (4) should be applied.

The lateral slip modulus K_{ser} for the serviceability limit state of screws in non-pre-drilled holes is given in EN 1995-1-1 (Eurocode 5) clause 7.1 and table 7.1 as for nails in non-pre-drilled holes.

The lateral slip modulus K_{ser} for the serviceability limit state of screws in pre-drilled holes is given in EN 1995-1-1 (Eurocode 5) clause 7.1 and table 7.1 as for nails in pre-drilled holes.

The lateral slip modulus K_{ser} for the serviceability limit state of a "HBS", "HBSP", "SHS" or "TBS" screw loaded in single shear in softwood LVL and $5 \text{ mm} \leq d \leq 10 \text{ mm}$ should be taken independent of angle α to the grain as:

$$K_{ser} = 60 \cdot \left(\frac{d \cdot \rho_{mean}}{510} \right)^{1,5} \quad [\text{N/mm}]$$

Where:

d outer thread diameter [mm],

ρ_{mean} softwood LVL mean density [kg/m³];

Axial withdrawal capacity

The characteristic axial withdrawal capacity of Rotho Blaas screws or threaded rods (only softwood) in solid timber (softwood and hardwood with a maximum characteristic density of 590 kg/m³), glued laminated timber (softwood and hardwood with a maximum characteristic density of 590 kg/m³), cross-laminated timber or laminated veneer lumber (softwood and hardwood or FST according to ETA-14/0354 with maximum characteristic density of 750 kg/m³) members at an angle of $0^\circ \leq \alpha \leq 90^\circ$ to the grain shall be calculated according to EN 1995-1-1:2008 from:

$$F_{ax,\alpha,Rk} = \frac{n_{ef} \cdot k_{ax} \cdot f_{ax,k} \cdot d \cdot \ell_{ef}}{k_\beta} \left(\frac{\rho_k}{\rho_a} \right)^{0,8} \quad [\text{N}]$$

Where

$F_{ax,\alpha,Rk}$	characteristic withdrawal capacity of the screws at an angle α to the grain [N]	α	angle between grain and screw axis, $0^\circ \leq \alpha \leq 90^\circ$, for threaded rods $15^\circ \leq \alpha \leq 90^\circ$,
n_{ef}	effective number of screws according to EN 1995-1-1:2008	β	angle between screw axis and the LVL's wide face ($0^\circ \leq \alpha \leq 90^\circ$)
k_{ax}	$k_{ax} = 1,0$ for $45^\circ \leq \alpha \leq 90^\circ$ $k_{ax} = a + \frac{b \cdot \alpha}{45^\circ}$ for $0^\circ \leq \alpha < 45^\circ$ $a = \begin{cases} 0,5 & \text{for LVL} \\ 0,3 & \text{for timber} \end{cases}$ $b = \begin{cases} 0,5 & \text{for LVL} \\ 0,7 & \text{for timber} \end{cases}$	ρ_k	characteristic density [kg/m ³]
k_β	$k_\beta = 1,0$ for timber $k_\beta = 1,5 \cdot \cos^2 \beta + \sin^2 \beta$ for LVL	ρ_a	associated density for $f_{ax,k}$ [kg/m ³]
$f_{ax,k}$	Characteristic withdrawal parameter For screws in solid or glued laminated timber, cross laminated timber and SWP members with maximum characteristic density of 440 kg/m ³ and $\rho_a = 350$ kg/m ³ : $f_{ax,k} = 11,7$ N/mm ² For threaded rods in solid or glued laminated timber and cross laminated timber members with maximum characteristic density of 440 kg/m ³ and $\rho_a = 350$ kg/m ³ : $f_{ax,k} = 9,0$ N/mm ² For screws in non pre-drilled LVL with 460 kg/m ³ $\leq \rho_k \leq 550$ kg/m ³ and $\rho_a = 500$ kg/m ³ : $f_{ax,k} = 15,0$ N/mm ² For KKT screws in hardwood members (Oak or Beech) with maximum characteristic density of 590 kg/m ³ and $\rho_a = 530$ kg/m ³ : $f_{ax,k} = 28,0$ N/mm ² For screws in pre-drilled LVL or FST (ETA-14/0354) with 590 kg/m ³ $\leq \rho_k \leq 750$ kg/m ³ and $\rho_a = 730$ kg/m ³ : $f_{ax,k} = 29,0$ N/mm ² For HBSH, VGZH, VGSH screws in non-pre-drilled LVL or FST (ETA-14/0354) with 590 kg/m ³ $\leq \rho_k \leq 750$ kg/m ³ and $\rho_a = 730$ kg/m ³ : $f_{ax,k} = 42,0$ N/mm ² For screws in pre-drilled hardwood members with maximum characteristic density of 590 kg/m ³ : $f_{ax,k} = 7 \cdot 10^{-4} \cdot \rho_k^{1,6} \cdot d^{-0,34}$ N/mm ² For HBSH, VGSH and VGZH screws in non-pre-drilled hardwood members (oak, beech) with maximum characteristic density of 590 kg/m ³ and $\rho_a = 530$ kg/m ³ : $f_{ax,k} = 22,0$ N/mm ² For HBSH, VGSH and VGZH screws in non-pre-drilled hardwood members (ash) with maximum characteristic density of 590 kg/m ³ and $\rho_a = 530$ kg/m ³ : $f_{ax,k} = 30,0$ N/mm ²		
d	outer thread diameter [mm]		
ℓ_{ef}	penetration length of the threaded part according to EN 1995-1-1:2008 [mm]		

For screws or threaded rods penetrating more than one layer of cross laminated timber, the different layers may be taken into account proportionally.

The axial withdrawal capacity for screws arranged parallel to the plane of cross laminated timber, independent of the angle between screw axis and grain direction, $0^\circ \leq \alpha \leq 90^\circ$, may be calculated from:

$$F_{ax,Rk} = 20 \cdot d^{0,8} \cdot \ell_{ef}^{0,9} \quad [N]$$

Where

d outer thread diameter [mm][^]

ℓ_{ef} Penetration length of the threaded part according to EN 1995-1-1:2008 [mm]

The axial withdrawal capacity is limited by the head pull-through capacity and the tensile capacity of the screw.

For axially loaded screws or threaded rods in tension, where the external force is parallel to the screw axes, the rules in EN 1995-1-1, 8.7.2 (8) should be applied.

For inclined screws or threaded rods in timber-to-timber or steel-to-timber shear connections, where the screws or threaded rods are arranged under an angle $30^\circ \leq \alpha \leq 60^\circ$ between the shear plane and the screw axis, the effective number of screws n_{ef} should be determined as follows:

For one row of n screws or threaded rods parallel to the load, the load-carrying capacity should be calculated using the effective number of fasteners n_{ef} , where

$$n_{ef} = \max \{ n^{0,9}; 0,9 \cdot n \}$$

and n is the number of inclined screws or threaded rods in a row. If crossed pairs of screws or threaded rods are used in timber-to-timber connections, n is the number of crossed pairs of screws or threaded rods in a row.

Note: For screws or threaded rods as reinforcement or inclined screws or threaded rods as fasteners in mechanically jointed beams or columns or for the fixing of thermal insulation material, $n_{ef} = n$.

The axial slip modulus K_{ser} of the threaded part of a screw or threaded rod for the serviceability limit state should be taken independent of angle α to the grain as:

$$K_{ser} = 25 \cdot d \cdot \ell_{ef} \quad [N/mm] \quad \text{for fasteners in softwood}$$

$K_{ser} = 30 \cdot d \cdot \ell_{ef}$ [N/mm] for screws in hardwood

Where

d outer thread diameter [mm]
 ℓ_{ef} penetration length in the timber member [mm]

Head pull-through capacity

The characteristic head pull-through capacity of Rotho Blaas screws in softwoods, hardwoods and wood-based panels shall be calculated according to EN 1995-1-1:2008 from:

$$F_{ax,\alpha,Rk} = n_{ef} \cdot f_{head,k} \cdot d_h^2 \cdot \left(\frac{\rho_k}{\rho_a} \right)^{0,8} \quad [N]$$

where:

$F_{ax,\alpha,Rk}$ characteristic head pull-through capacity of the connection at an angle $\alpha \geq 30^\circ$ to the grain [N]
 n_{ef} effective number of screws according to EN 1995-1-1:2008
 For inclined screws: $n_{ef} = \max \{ n^{0,9}; 0,9 \cdot n \}$
 (see axial withdrawal capacity)
 $f_{head,k}$ characteristic head pull-through parameter [N/mm²]
 d_h diameter of the screw head or the washer [mm]. Outer diameter of washers $d_k > 32$ mm shall not be considered.
 ρ_k characteristic density [kg/m³], for wood-based panels maximum $\rho_k = 380$ kg/m³, for hardwood maximum $\rho_k = 590$ kg/m³

Characteristic head pull-through parameter for Rotho Blaas screws or for washer except “KKF” and “KKT” screws in connections with softwood and in connections with wood-based panels with thicknesses above 20 mm and $\rho_a = 350$ kg/m³:

$$f_{head,k} = 10,5 \text{ N/mm}^2$$

Characteristic head pull-through parameter for Rotho Blaas “TBS” screws $d = 8$ mm with $d_k = 24,5$ mm in connections with softwood and in connections with wood-based panels with thicknesses above 20 mm and $\rho_a = 350$ kg/m³:

$$f_{head,k} = 15 \text{ N/mm}^2$$

Characteristic head pull-through parameter for Rotho Blaas “KKF” and “KKT” screws in connections with softwood and in connections with wood-based panels with thicknesses above 20 mm and $\rho_a = 350$ kg/m³:

$$f_{head,k} = 16,5 \text{ N/mm}^2$$

Characteristic head pull-through parameter for Rotho Blaas screws with countersunk head in connections with softwood LVL and $\rho_a = 500$ kg/m³:

$$f_{head,k} = 20 \text{ N/mm}^2$$

Characteristic head pull-through parameter for Rotho Blaas “KKF”, “KKT” and “MN” screws in connections with hardwood and $\rho_a = 530$ kg/m³:

$$f_{head,k} = 28 \text{ N/mm}^2$$

Characteristic head pull-through parameter for Rotho Blaas “HBSH” screws with countersunk head 60° in connections with Beech LVL or FST (ETA-14/0354) with maximum $\rho_k = 750$ kg/m³ and $\rho_a = 730$ kg/m³:

$$f_{head,k} = 50 \text{ N/mm}^2$$

Characteristic head pull-through parameter for screws in connections with wood-based panels with thicknesses between 12 mm and 20 mm:

$$f_{head,k} = 8 \text{ N/mm}^2$$

Characteristic head pull-through parameter for Rotho Blaas “HBSH” screws $d = 6,0$ mm in connections with hardwood (oak, beech, ash) and $\rho_a = 530$ kg/m³:

$$f_{head,k} = 28,0 \text{ N/mm}^2$$

Characteristic head pull-through parameter for Rotho Blaas “HBSH” screws $d = 8,0$ mm in connections with hardwood (oak, beech, ash) and $\rho_a = 530$ kg/m³:

$$f_{head,k} = 24,0 \text{ N/mm}^2$$

Screws in connections with wood-based panels with a thickness below 12 mm (minimum thickness of the wood based panels of $1,2 \cdot d$ with d as outer thread diameter):

$$f_{head,k} = 8 \text{ N/mm}^2$$

limited to $F_{ax,Rk} = 400$ N

The head diameter d_h of all screws except “KKF” and “KKT” screws shall be greater than $1,8 \cdot d_s$, where d_s is the smooth shank or the wire diameter. Otherwise the characteristic head pull-through capacity $F_{ax,\alpha,Rk} = 0$.

The minimum thickness of wood-based panels according to the clause 3.12 must be observed.

In steel-to-timber connections the head pull-through capacity may be disregarded.

Tensile capacity

The characteristic tensile strength $f_{tens,k}$ of screws or threaded rods made from carbon steel except “HBSH”, “VGZH”, “VGSH” and of screws “KKF” and “GHKF” screws made from stainless steel is:

Screw $d = 3,0$ mm:	2,8 kN
Screw $d = 3,5$ mm:	3,8 kN
Screw $d = 4,0$ mm:	5,0 kN
Screw $d = 4,5$ mm:	6,4 kN
Screw $d = 5,0$ mm:	7,9 kN
Screw $d = 5,3$ mm:	11,0 kN
Screw $d = 5,6$ mm:	12,5 kN
Screw $d = 6,0$ mm:	11,3 kN
Screw $d = 7,0$ mm:	15,4 kN
Screw $d = 8,0$ mm:	20,1 kN
Screw $d = 9,0$ mm:	25,4 kN

Screw d = 10,0 mm:	31,4 kN
Screw d = 11,0 mm:	38,0 kN
Screw d = 12,0 mm:	33,9 kN
Screw d = 13,0 mm:	53,0 kN
Rod d = 16,0 mm:	100 kN
Rod d = 20,0 mm:	145 kN

The characteristic tensile strength $f_{tens,k}$ of “HBSH”, “VGZH”, “VGSH” screws made from carbon steel is:

Screw d = 6,0 mm:	18 kN
Screw d = 8,0 mm:	32 kN

The characteristic tensile strength $f_{tens,k}$ of screws made from stainless steel “KKT”, “MN” and “SCI“ is:

Screw d = 3,5 mm:	2,1 kN
Screw d = 4,0 mm:	2,8 kN
Screw d = 4,5 mm:	3,5 kN
Screw d = 5,0 mm:	4,3 kN
Screw d = 6,0 mm:	6,2 kN
Screw d = 8,0 mm:	11,1 kN

For screws used in combination with steel plates, the tear-off capacity of the screw head should be greater than the tensile strength of the screw.

When determining design values of the tensile capacity it should be used γ_{M2} partial factor according to EN 1993 or to the particular national annex.

Combined laterally and axially loaded screws or threaded rods

For connections subjected to a combination of axial and lateral load, the following expression should be satisfied:

$$\left(\frac{F_{ax,Ed}}{F_{ax,Rd}}\right)^2 + \left(\frac{F_{la,Ed}}{F_{la,Rd}}\right)^2 \leq 1$$

where

$F_{ax,Ed}$	axial design load of the screw or threaded rod
$F_{la,Ed}$	lateral design load of the screw or threaded rod
$F_{ax,Rd}$	design load-carrying capacity of an axially loaded screw or threaded rod
$F_{la,Rd}$	design load-carrying capacity of a laterally loaded screw or threaded rod

Mechanically jointed beams

“VGS”, “VGZ”, “VGSH” and “VGZH” screws with a full thread or “RTR” threaded rods may be used for connections in structural members which are composed of several parts in mechanically jointed beams or columns.

Compressive capacity

The design compressive capacity $F_{c,90,Rd}$ of “VGZ”, “VGS”, “VGZH” and “VGSH” screws or “RTR” threaded rods with full thread along the length embedded in timber with an angle between fastener axis and grain direction of $45^\circ \leq \alpha \leq 90^\circ$ is the minimum of the axial resistance against pushing-in and the buckling resistance:

$$F_{c,90,Rd} = \min \{ F_{ax,Rd}; F_{ki,Rd} \}$$

$$F_{c,90,Rd} = \min \left\{ f_{ax,d} \cdot d \cdot \ell_{ef} \cdot \left(\frac{\rho_k}{\rho_a} \right)^{0,8}; \frac{k_c \cdot N_{pl,k}}{\gamma_{M1}} \right\}$$

Where:

$$k_c = \begin{cases} 1 & \text{for } \bar{\lambda}_k \leq 0,2 \\ \frac{1}{k + \sqrt{k^2 - \bar{\lambda}_k^2}} & \text{for } \bar{\lambda}_k > 0,2 \end{cases}$$

$$k = 0,5 \cdot [1 + 0,49 \cdot (\bar{\lambda}_k - 0,2) + \bar{\lambda}_k^2]$$

The relative slenderness ratio shall be calculated from:

$$\bar{\lambda}_k = \sqrt{\frac{N_{pl,k}}{N_{ki,k}}}$$

where

$$N_{pl,k} = \pi \cdot \frac{d_1^2}{4} \cdot f_{y,k} \quad [N]$$

is the characteristic value for the axial capacity in case of plastic analysis referred to the inner thread cross-section.

Characteristic yield strength of screws from carbon steel:
 $f_{y,k} = 1000$ [N/mm²]

Characteristic yield strength of threaded rods:
 $f_{y,k} = 640$ [N/mm²]

Characteristic ideal elastic buckling load:
 $N_{ki,k} = \sqrt{c_h \cdot E_s \cdot I_s}$ [N]

Elastic foundation of the screw or threaded rod:

$$c_h = (0,19 + 0,012 \cdot d) \cdot \rho_k \cdot \left(\frac{\alpha}{180^\circ} + 0,5 \right) \quad [N/mm^2]$$

Modulus of elasticity:
 $E_s = 210000$ [N/mm²]

Second moment of area:

$$I_s = \frac{\pi}{64} \cdot d_1^4 \quad [mm^4]$$

$f_{ax,d}$ design value of the axial withdrawal parameter of the threaded part of the screw [N/mm²]

d_1 inner thread diameter [mm]

d outer thread diameter [mm]

ℓ_{ef} penetration length of the threaded part [mm]

α angle between screw axis and grain direction

ρ_k characteristic density [kg/m³]

ρ_a associated density for $f_{ax,k}$ [kg/m³]

γ_{M1} partial factor according to EN 1993 or to the particular national annex

Compression reinforcement

See Annex C

Thermal insulation material on top of rafters

See Annex D

Shear reinforcement

See Annex E

Tensile reinforcement

See Annex F

3.11 Aspects related to the performance of the product**3.11.1 Corrosion protection**

The Rotho Blaas screws or threaded rods are produced from steel wire. Screws or threaded rods made from carbon steel are electrogalvanised and yellow or blue chromate or could be coated with organic coating. The thickness of the zinc coating is minimum 5 µm.

The screws are for use in timber structures subject to service classes 1, 2 and 3 of Eurocode 5. In service class 1 and 2 the corrosion protection is given according to EN1995-1-1, or by equivalent measures.

In service class 3 the corrosion protection is given according to EN1995-1-1 or by stainless steel no. 1.4006, 1.4401 and 1.4567. Alternatively, a Zn-Al flakes coating (also called "evo coating") can be used as corrosion protection in service class 3.

Contact corrosion shall be avoided.

3.12 General aspects related to the intended use of the product

The screws or threaded rods are manufactured in accordance with the provisions of the ETA using the automated manufacturing process and laid down in the technical documentation.

The installation shall be carried out in accordance with Eurocode 5 or an appropriate national code unless otherwise is defined in the following. Instructions from Rotho Blaas s.r.l should be considered for installation.

The screws or threaded rods are used for connections in load bearing timber structures between members of solid timber, glued laminated timber, cross-laminated timber, laminated veneer lumber, similar glued members, wood-based panels or steel members.

The screws or threaded rods may be used for connections in load bearing timber structures with structural members according to an associated ETA, if according to the associated ETA of the structural member a connection in load bearing timber structures with screws according to an ETA is allowed.

Rotho Blaas fully threaded "VGS", "VGZ", "VGSH" and "VGZH" screws or "RTR" threaded rods are also used as

tensile or compressive reinforcement perpendicular to the grain or as shear reinforcement.

Furthermore the screws with diameters of at least 6 mm may also be used for the fixing of insulation on top of rafters.

A minimum of two screws or threaded rods should be used for connections in load bearing timber structures. This does not apply for reinforcements or for the fixing of battens, rafters, purlins or similar on main beams or top plates, if the member is fixed with at least two screws in total.

The minimum penetration depth in structural members made of solid, glued or cross-laminated timber or laminated veneer lumber is:

$$l_{ef,req} = \min \left\{ \frac{4 \cdot d}{\sin \alpha}; 20 \cdot d \right\}$$

Wood-based panels and steel plates should only be arranged on the side of the screw head. The minimum thickness of wood-based panels should be $1,2 \cdot d$. Furthermore, the minimum thickness for following wood-based panels should be:

- Plywood, Fibreboards: 6 mm
- Particleboards, OSB, Cement Particleboards: 8 mm
- Solid wood panels: 12 mm

For structural members according to ETA's the terms of the ETA's must be considered.

If screws with an outer thread diameter $d > 8$ mm are used in load bearing timber structures, the structural solid or glued laminated timber, laminated veneer lumber and similar glued members must be from spruce, pine or fir. This does not apply for screws or threaded rods in pre-drilled holes.

The screws shall be driven into softwood with or without pre-drilling. The threaded rods shall be driven into softwood with pre-drilling. Except "HBSH", "VGSH", "VGZH" or "KKT" screws, the screws shall be driven into hardwood with a maximum characteristic density of 590 kg/m³ after pre-drilling. "HBSH", "VGSH", "VGZH" screws made of carbon steel may be driven into Beech LVL according to EN 14374 or in FST according to ETA-14/0354 without pre-drilling or after pre-drilling.

The maximum total penetration length of “VGZH” and “VGSH” screws with 6 mm or 8 mm diameter without pre-drilling or after partial pre-drilling is limited to:

Outer thread diameter [mm]	Maximum total penetration length [mm]	
	Hardwood non-predrilled	Beech LVL with pilot hole
6,0	260	180 mm with pilot hole ≥ 50 mm
		260 mm with pilot hole ≥ 110 mm
8,0	320	280 mm with pilot hole ≥ 100 mm
		320 mm with pilot hole ≥ 150 mm

The drill hole diameters are:

Outer thread diameter [mm]	Drill hole diameter [mm]	
	Softwood	Hardwood
3,0	2,0	-
3,5	2,0	-
4,0	2,5	-
4,5	2,5	-
5,0	3,0	3,5
5,3	3,5	4,0
5,6	3,5	4,0
6,0	4,0	4,0
7,0	4,0	5,0
8,0	5,0	6,0
9,0	5,0	6,0
10,0	6,0	7,0
11,0	6,0	7,0
12,0	7,0	8,0
13,0	8,0	9,0
16,0	13,0	-
20,0	16,0	-

The hole diameter in steel members must be predrilled with a suitable diameter.

Only the equipment prescribed by Rotho Blaas SRL shall be used for driving the screws.

In connections with screws with countersunk head according to Annex A, the head must be flush with the surface of the connected structural member. A deeper countersink is not allowed.

For screws or threaded rods arranged at angles $\alpha < 90^\circ$ between screw axis and grain direction minimum spacing and distances are defined as follows:

Minimum spacing a_1 or a_2 is defined perpendicular to the fastener axis, minimum end or edge distances $a_{1,c}$, $a_{1,t}$, $a_{2,c}$ or $a_{2,t}$ parallel or perpendicular to the grain, respectively,

are defined between the centre of the threaded length (axial loading) or the length (lateral loading) in the respective timber member and the member surface as for axially loaded screws in Figure 8.11.a EN 1995-1-1.

Laterally and/or axially loaded screws or threaded rods

For structural timber members, minimum spacing and distances for laterally or axially loaded screws or threaded rods in predrilled holes are given in EN 1995-1-1:2008 (Eurocode 5) clause 8.3.1.2 and table 8.2 as for nails in predrilled holes. Here, the outer thread diameter d must be considered.

For threaded rods, the minimum timber member thickness is $4 \cdot d$ where d is the outer thread diameter.

For screws in non-predrilled holes, minimum spacing and distances are given in EN 1995-1-1:2008 (Eurocode 5) clause 8.3.1.2 and table 8.2 as for nails in non-predrilled holes.

Minimum distances and spacing for “KKT” screws in non-predrilled holes in members with a minimum thickness $t = 4 \cdot d$ and a minimum width of $12 \cdot d$ or 60 mm, whichever is the greater, may be taken as:

Spacing a_1 parallel to the grain	$a_1 = 8 \cdot d$
Spacing a_2 perpendicular to the grain	$a_2 = 4 \cdot d$
Loaded end distance:	$a_{3,t} = 12 \cdot d$
Unloaded end distance:	$a_{3,c} = 5 \cdot d$
Loaded edge distance:	$a_{4,t} = 5 \cdot d$
Unloaded edge distance:	$a_{4,c} = 4 \cdot d$

For Douglas fir members minimum spacing and distances parallel to the grain shall be increased by 50%.

Minimum distances from the unloaded edge perpendicular to the grain may be reduced to $3 \cdot d$ also for timber thickness $t < 5 \cdot d$, if the spacing parallel to the grain and the end distance is at least $25 \cdot d$.

These requirements do not apply for structural wood-based panels or LVL with cross layers.

Exclusively axially loaded screws or threaded rods

Minimum distances and spacing for exclusively axially loaded screws in predrilled and non-predrilled holes and for threaded rods in predrilled holes in members with a minimum thickness $t = 12 \cdot d$ and a minimum width of $8 \cdot d$ or 60 mm, whichever is the greater, may be taken as:

Spacing a_1 parallel to the grain	$a_1 = 5 \cdot d$
Spacing a_2 perpendicular to the grain	$a_2 = 5 \cdot d$
Distance $a_{1,CG}$ from centre of the screw-part in timber to the end grain	$a_{1,CG} = 10 \cdot d$
Distance $a_{2,CG}$ from centre of the screw-part in timber to the edge	$a_{2,CG} = 4 \cdot d$

Spacing a_2 perpendicular to the grain may be reduced from $5 \cdot d$ to $2,5 \cdot d$, if the condition $a_1 \cdot a_2 \geq 25 \cdot d^2$ is fulfilled.

Minimum distances and spacing for inclined or crossed "VGZ" screws $d = 7$ mm in joist-to-header connections arranged under 45° to the joist's end grain surface with a minimum joist depth of $18 \cdot d$ may be taken as:

Distance $a_{1,CG}$ from centre of the screw-part in timber to the unloaded joist end $a_{1,CG} = 8 \cdot d$
 Distance $a_{2,CG}$ from centre of the screw-part in timber to the unloaded joist edge $a_{2,CG} = 3 \cdot d$

For a crossed screw or threaded rod couple the minimum spacing between the crossing screws is $a_2 = 1,5 \cdot d$.

Minimum thickness for predrilled structural members is $t = 24$ mm for screws with outer thread diameter $d < 8$ mm, $t = 30$ mm for screws with outer thread diameter $d = 8$ mm, $t = 40$ mm for screws with outer thread diameter $d \geq 9$ mm, $t = 80$ mm for screws with outer thread diameter $d \geq 11$ mm and $t = 100$ mm for screws or threaded rods with outer thread diameter $d \geq 13$ mm. These minimum thickness values generally apply for non-predrilled softwood members, if the spacing parallel to the grain and the end distance is at least $25 \cdot d$.

In all other cases, minimum thicknesses for screws in non-predrilled softwood members are given in EN 1995-1-1 (Eurocode 5) clause 8.3.1.2 as for nails in non-predrilled holes. Equation (8.18) may be applied for softwood members made of pine or for the fixing of boards, battens or wind braces, if the member is fixed with at least two screws. Otherwise EN 1995-1-1 clause 8.3.1.2 (7) applies.

Cross Laminated Timber

Unless specified otherwise in the technical specification (ETA or hEN) of cross laminated timber, minimum distances and spacing for screws or threaded rods in the wide face of cross laminated timber members with a minimum thickness $t = 10 \cdot d$ may be taken as (see Annex B):

Spacing a_1 parallel to the grain $a_1 = 4 \cdot d$
 Spacing a_2 perpendicular to the grain $a_2 = 2,5 \cdot d$
 Distance $a_{3,c}$ from centre of the screw-part in timber to the unloaded end grain $a_{3,c} = 6 \cdot d$
 Distance $a_{3,t}$ from centre of the screw-part in timber to the loaded end grain $a_{3,t} = 6 \cdot d$
 Distance $a_{4,c}$ from centre of the screw-part in timber to the unloaded edge $a_{4,c} = 2,5 \cdot d$
 Distance $a_{4,t}$ from centre of the screw-part in timber to the loaded edge $a_{4,t} = 6 \cdot d$

Unless specified otherwise in the technical specification (ETA or hEN) of cross laminated timber, minimum distances and spacing for screws or threaded rods in the edge surface of cross laminated timber members with a minimum thickness $t = 10 \cdot d$ and a minimum penetration depth

perpendicular to the edge surface of $10 \cdot d$ may be taken as (see Annex B):

Spacing a_1 parallel to the CLT plane $a_1 = 10 \cdot d$
 Spacing a_2 perpendicular to the CLT plane $a_2 = 4 \cdot d$
 Distance $a_{3,c}$ from centre of the screw-part in timber to the unloaded end $a_{3,c} = 7 \cdot d$
 Distance $a_{3,t}$ from centre of the screw-part in timber to the loaded end $a_{3,t} = 12 \cdot d$
 Distance $a_{4,c}$ from centre of the screw-part in timber to the unloaded edge $a_{4,c} = 3 \cdot d$
 Distance $a_{4,t}$ from centre of the screw-part in timber to the loaded edge $a_{4,t} = 6 \cdot d$

Laminated Veneer Lumber

Unless specified otherwise in the technical specification (ETA or hEN) of softwood LVL, minimum distances and spacing for "HBS", "HBSH", "HBSP", "SHS" and "TBS" screws $5 \text{ mm} \leq d \leq 10 \text{ mm}$ perpendicular to the wide face of softwood LVL members with a minimum side member thickness $t_1 = 8,4 \cdot d - 9 \text{ mm}$ and a minimum central member thickness in double shear connections $t_2 = \min\{11,4 \cdot d; 75 \text{ mm}\}$ may be taken as:

Spacing a_1 parallel to the grain $a_1 = (5 + 7 |\cos \alpha|)d$
 Spacing a_2 perpendicular to the grain $a_2 = 5 \cdot d$
 Distance $a_{3,c}$ to the unloaded end grain $a_{3,c} = 10 \cdot d$
 Distance $a_{3,t}$ to the loaded end grain $a_{3,t} = (10 + 5 \cos \alpha)d$
 Distance $a_{4,c}$ to the unloaded edge $a_{4,c} = 5 \cdot d$
 Distance $a_{4,t}$ to the loaded edge $a_{4,t} = (5 + 5 \sin \alpha)d$

Unless specified otherwise in the technical specification (ETA or hEN) of softwood LVL, minimum distances and spacing for exclusively axially loaded screws "VGZ", "VGZH" "VGS" or "VGS" with $d = 7$ mm or $d = 9$ mm in the edge surface of softwood LVL members with a minimum LVL panel thickness $t = 45$ mm ($d = 6$ mm and $d = 7$ mm) or $t = 57$ mm ($d = 8$ mm and $d = 9$ mm) and a minimum LVL member depth $h = 100$ mm ($d = 6$ mm and $d = 7$ mm) or $h = 120$ mm ($d = 8$ mm and $d = 9$ mm) may be taken as:

Spacing a_1 parallel to the grain $a_1 = 10 \cdot d$
 Distance $a_{1,CG}$ from centre of the screw-part in timber to the unloaded end $a_{1,CG} = 12 \cdot d$
 Distance $a_{2,CG}$ from centre of the screw-part in timber to the unloaded edge $a_{2,CG} = 3 \cdot d$

4 Attestation and verification of constancy of performance (AVCP)

4.1 AVCP system

According to the decision 97/176/EC of the European Commission¹, as amended, the system(s) of assessment and verification of constancy of performance (see Annex V to Regulation (EU) No 305/2011) is 3.

5 Technical details necessary for the implementation of the AVCP system, as foreseen in the applicable EAD

Technical details necessary for the implementation of the AVCP system are laid down in the control plan deposited at ETA-Danmark prior to CE marking.

Issued in Copenhagen on 2020-12-10 by

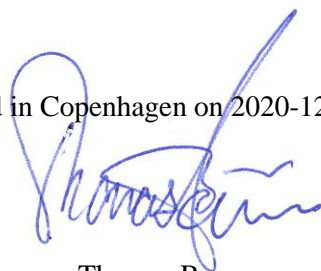

Thomas Bruun
Managing Director, ETA-Danmark

Annex A Drawings of Rotho Blaas screws

Annex A.01

Rotho Blaas screws



CARBON STEEL
PARTIAL THREAD
Ø 3.0 mm

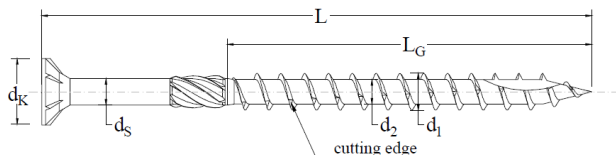

Alternative names:
HBS/SCH/SNK/GHS

Alternative head types:

Headstamps (supplier head mark and specific length) optional.

countersunk head
with or without milling
ribs under head

"CS"

d₁	3.00
d_K	6.00 ±0.50

Alternative thread tip types:

"RBN"
with or without
cutting edge

"RBN2"
with or without
cutting edge

Secondary rough thread optional.

	d₁	d₂	d_s
"RBN"	3.00 ±0.30	2.00 ±0.30	2.16 ±0.30
"RBN2"	3.00 ±0.30	2.00 ±0.30	2.16 ±0.30

Lengths and Thread Lengths

d₁	L		L_G	
	min	max	min	max
3.00	20.0	40.0	12.0	35.0

Tolerance (L and L_G): according to EAD 130118-01-0603.
Intermediate lengths (L) are possible.
Intermediate thread lengths (L_G) are possible.

All dimensions in [mm].

CARBON STEEL
PARTIAL THREAD
Ø 3.5 mm

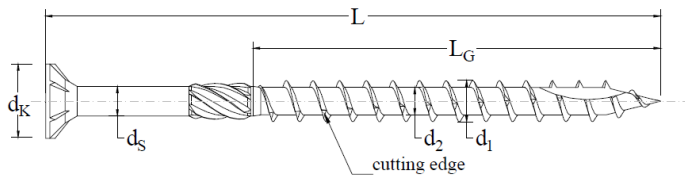

Alternative names:
HBS/SCH/SNK/GHS

Alternative head types:

Headstamps (supplier head mark and specific length) optional.

countersunk head
with or without milling
ribs under head

"CS"

d_1	3.50
d_K	7.00 ±0.50

Alternative thread tip types:

Secondary rough thread optional.

"RBN"
with or without
cutting edge

"RBN2"
with or without
cutting edge

	d_1	d_2	d_s
"RBN"	3.50 ±0.30	2.25 ±0.30	2.45 ±0.30
"RBN2"	3.50 ±0.30	2.25 ±0.30	2.45 ±0.30

Lengths and Thread Lengths

d_1	L		L_G	
	min	max	min	max
3.50	20.0	50.0	14.0	24.0

Tolerance (L and L_G): according to EAD 130118-01-0603.
Intermediate lengths (L) are possible.
Intermediate thread lengths (L_G) are possible.

All dimensions in [mm].

CARBON STEEL
PARTIAL THREAD
Ø 4.0 mm

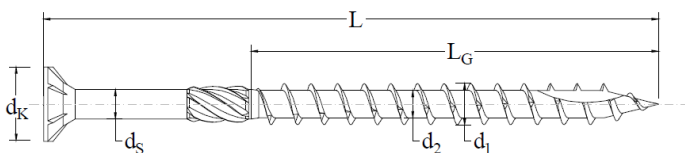

Alternative names:
HBS/SCH/SNK/GHS
HBSP/KGL/GHS+

Alternative head types:

Headstamps (supplier head mark and specific length) optional.

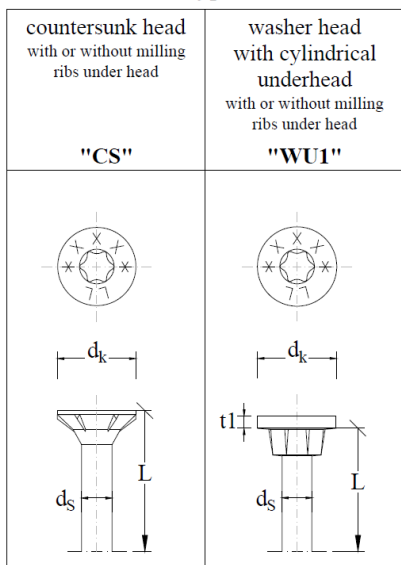

d ₁	4.00
d _K	8.00 ±0.60

d ₁	4.00
d _K	7.70 ±0.50
t ₁	1.00 ±0.30

Alternative thread tip types:

Secondary rough thread optional.

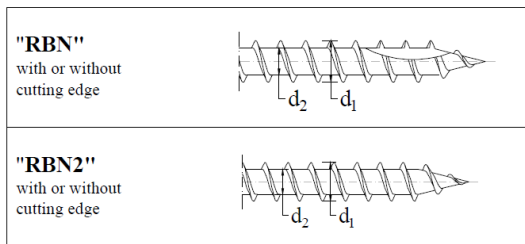

	d ₁	d ₂	d _s
"RBN"	4.00 ±0.30	2.55 ±0.30	2.75 ±0.30
"RBN2"	4.00 ±0.30	2.55 ±0.30	2.75 ±0.30

Lengths and Thread Lengths

d ₁	L		L _G	
	min	max	min	max
4.00	25.0	80.0	16.0	40.0

Tolerance (L and L_G): according to EAD 130118-01-0603.
Intermediate lengths (L) are possible.
Intermediate thread lengths (L_G) are possible.

All dimensions in [mm].

CARBON STEEL
PARTIAL THREAD
Ø 4.5 mm

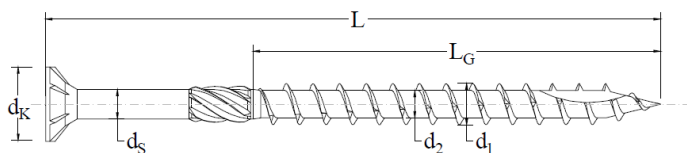

Alternative names:
HBS/SCH/SNK/GHS
HBSP/KGL/GHS+

Alternative head types:

Headstamps (supplier head mark and specific length) optional.

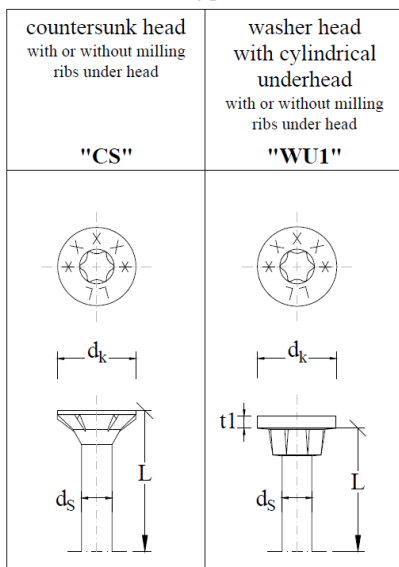

d ₁	4.50
d _K	9.00 ±0.60

d ₁	4.50
d _K	8.70 ±0.60
t ₁	1.00 ±0.30

Alternative thread tip types:

Secondary rough thread optional.

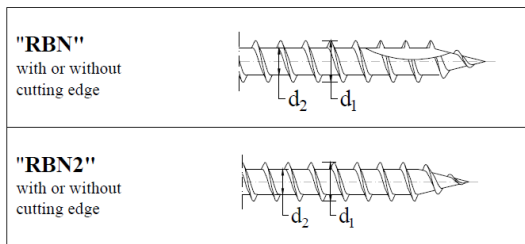

	d ₁	d ₂	d _s
"RBN"	4.50 ±0.30	2.80 ±0.30	3.15 ±0.30
"RBN2"	4.50 ±0.30	2.80 ±0.30	3.15 ±0.30

Lengths and Thread Lengths

d ₁	L		L _G	
	min	max	min	max
4.50	25.0	80.0	18.0	40.0

Tolerance (L and L_G): according to EAD 130118-01-0603.
Intermediate lengths (L) are possible.
Intermediate thread lengths (L_G) are possible.

All dimensions in [mm].

CARBON STEEL
PARTIAL THREAD
Ø 5.0 mm

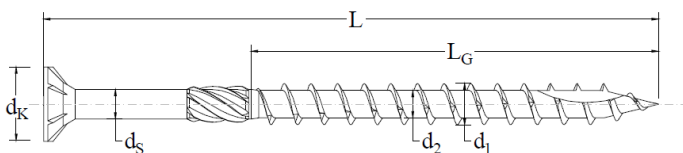

Alternative names:
HBS/SCH/SNK/GHS
HBSP/KGL/GHS+
SHS

Alternative head types:

Headstamps (supplier head mark and specific length) optional.

countersunk head with or without milling ribs under head	washer head with cylindrical underhead with or without milling ribs under head	countersunk head 60° with or without milling ribs under head
"CS"	"WU1"	"CS60"

d ₁	5.00
d _K	10.00 ±0.60

d ₁	5.00
d _K	9.65 ±0.60
t ₁	1.00 ±0.30

d ₁	5.00
d _K	10.00 ±0.60

Alternative thread tip types:

Secondary rough thread optional.

"RBN" with or without cutting edge	
"RBN2" with or without cutting edge	

	d ₁	d ₂	d _s
"RBN"	5.00 ±0.30	3.40 ±0.30	3.65 ±0.30
"RBN2"	5.00 ±0.30	3.40 ±0.30	3.65 ±0.30

Lengths and Thread Lengths

d ₁	L		L _G	
	min	max	min	max
5.00	30.0	120.0	20.0	60.0

Tolerance (L and L_G): according to EAD 130118-01-0603.
Intermediate lengths (L) are possible.
Intermediate thread lengths (L_G) are possible.

All dimensions in [mm].

Annex A.06

Rotho Blaas screws



CARBON STEEL
PARTIAL THREAD
Ø 6.0 mm

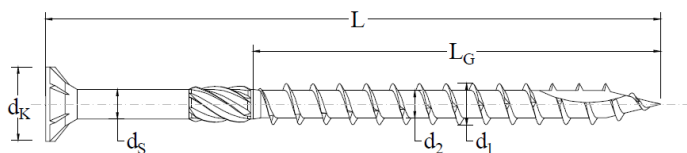

Alternative names:

HBS/SCH/SNK/GHS
HBSP/KGL/GHS+
TBS/TLL/GHSC
HBSH

Alternative head types:

Headstamps (supplier head mark and specific length) optional.

countersunk head with or without milling ribs under head	large washer head	large washer head	washer head with cylindrical underhead with or without milling ribs under head	countersunk head 60° with or without milling ribs under head
"CS"	"LW1"	"LW2"	"WU1"	"CS60"

d ₁	6.00
d _K	12.00 ±0.60

d ₁	6.00
d _K	15.50 ±0.78

d ₁	6.00
d _K	15.50 ±0.78

d ₁	6.00
d _K	12.00 ±0.60
t ₁	1.50 ±0.30

d ₁	6.00
d _K	12.00 ±0.60

Alternative thread tip types:

Secondary rough thread optional.

"RBN" with or without cutting edge	
"RBN2" with or without cutting edge	
"RBH" with or without cutting edge with or without cut with or without saw teeth	

	d ₁	d ₂	d _s
"RBN"	6.00 ±0.30	3.95 ±0.30	4.30 ±0.30
"RBN2"	6.00 ±0.30	3.95 ±0.30	4.30 ±0.30
"RBH"	6.00 ±0.30	4.50 ±0.30	4.80 ±0.30

Lengths and Thread Lengths

d ₁	L		L _G		Thread tip types
	min	max	min	max	
6.00	40.0	300.0	24.0	100.0	RBN - RBN2
6.00	80.0	160.0	24.0	90.0	RBH

Tolerance (L and L_G): according to EAD 130118-01-0603.
Intermediate lengths (L) are possible.
Intermediate thread lengths (L_G) are possible.

All dimensions in [mm].

CARBON STEEL
PARTIAL THREAD
Ø 8.0 mm

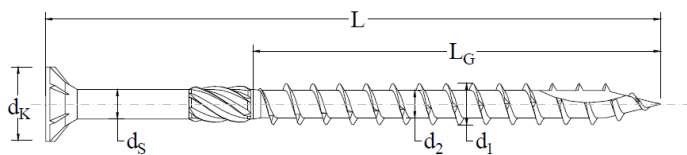

Alternative names:

HBS/SCH/SNK/GHS
HBSP/KGL/GHS+
TBS/TLL/GHSK
HBSH

Alternative thread tip types:

<p>"RBN" with or without cutting edge</p>
<p>"RBN2" with or without cutting edge</p>
<p>"RBH" with or without cutting edge with or without cut with or without saw teeth</p>

Secondary rough thread optional.

	d ₁	d ₂	d _s
"RBN"	8.00 ±0.40	5.40 ±0.30	5.80 ±0.30
"RBN2"	8.00 ±0.40	5.40 ±0.30	5.80 ±0.30
"RBH"	8.00 ±0.40	5.90 ±0.30	6.30 ±0.32

Lengths and Thread Lengths

d ₁	L		L _G		Thread tip types
	min	max	min	max	
8.00	40.0	520.0	32.0	130.0	RBN - RBN2
8.00	120.0	240.0	32.0	100.0	RBH

Tolerance (L and L_G): according to EAD 130118-01-0603.
Intermediate lengths (L) are possible.
Intermediate thread lengths (L_G) are possible.

All dimensions in [mm].

CARBON STEEL
PARTIAL THREAD
Ø 8.0 mm

Alternative head types:

Headstamps (supplier head mark and specific length) optional.

countersunk head with or without milling ribs under head	large washer head	large washer head	large washer head	large washer head	large washer head
"CS"	"LW1"	"LW1"	"LW2"	"LW2"	"LW3"

d₁	8.00
d_K	14.50 ±0.73

d₁	8.00
d_K	19.00 ±0.95

d₁	8.00
d_K	22.00 ±1.10

d₁	8.00
d_K	19.00 ±0.95

d₁	8.00
d_K	22.00 ±1.10

d₁	8.00
d_K	24.50 ±1.23

washer head with cylindrical underhead with or without milling ribs under head	washer head with cylindrical underhead with or without milling ribs under head	countersunk head 60° with or without milling ribs under head
"WU1"	"WU2"	"CS60"

d₁	8.00
d_K	14.50 ±0.73
t₁	1.75 ±0.30

d₁	8.00
d_K	14.50 ±0.73
t₁	3.40 ±0.30

d₁	8.00
d_K	14.50 ±0.73

All dimensions in [mm].

CARBON STEEL
PARTIAL THREAD
Ø 10.0 mm

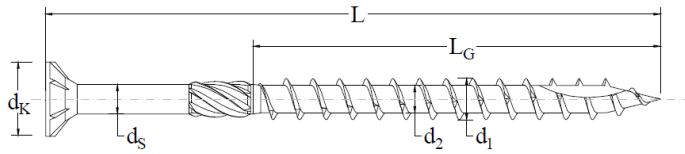

Alternative names:

HBS/SCH/SNK/GHS
HBSP/KGL/GHS+
TBS/TLL/GHSK

Alternative head types:

Headstamps (supplier head mark and specific length) optional.

countersunk head with or without milling ribs under head	large washer head	large washer head	washer head with cylindrical underhead with or without milling ribs under head	washer head with cylindrical underhead with or without milling ribs under head
"CS"	"LW1"	"LW2"	"WU1"	"WU2"

d₁	10.00
d_K	18.25 ±0.91

d₁	10.00
d_K	25.00 ±1.25

d₁	10.00
d_K	25.00 ±1.25

d₁	10.00
d_K	18.25 ±0.91
t₁	2.00 ±0.30

d₁	10.00
d_K	18.25 ±0.91
t₁	4.35 ±0.30

Alternative thread tip types:

Secondary rough thread optional.

"RBN" with or without cutting edge	
"RBN2" with or without cutting edge	

	d₁	d₂	d_s
"RBN"	10.00 ±0.50	6.40 ±0.32	7.00 ±0.35
"RBN2"	10.00 ±0.50	6.40 ±0.32	7.00 ±0.35

Lengths and Thread Lengths

d₁	L		L_G	
	min	max	min	max
10.00	60.0	520.0	40.0	150.0

Tolerance (L and L_G): according to EAD 130118-01-0603.
Intermediate lengths (L) are possible.
Intermediate thread lengths (L_G) are possible.

All dimensions in [mm].

CARBON STEEL
PARTIAL THREAD
Ø 12.0 mm

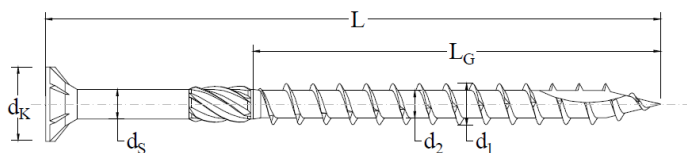

Alternative names:
HBS/SCH/SNK/GHS
HBSP/KGL/GHS+

Alternative head types:

Headstamps (supplier head mark and specific length) optional.

countersunk head with or without milling ribs under head	washer head with cylindrical underhead with or without milling ribs under head	washer head with cylindrical underhead with or without milling ribs under head																
"CS"	"WU1"	"WU2"																
<table border="1"> <tr><td>d₁</td><td>12.00</td></tr> <tr><td>d_K</td><td>20.75 ±1.04</td></tr> </table>	d ₁	12.00	d _K	20.75 ±1.04	<table border="1"> <tr><td>d₁</td><td>12.00</td></tr> <tr><td>d_K</td><td>20.75 ±1.04</td></tr> <tr><td>t₁</td><td>2.30 ±0.30</td></tr> </table>	d ₁	12.00	d _K	20.75 ±1.04	t ₁	2.30 ±0.30	<table border="1"> <tr><td>d₁</td><td>12.00</td></tr> <tr><td>d_K</td><td>20.75 ±1.04</td></tr> <tr><td>t₁</td><td>5.00 ±0.30</td></tr> </table>	d ₁	12.00	d _K	20.75 ±1.04	t ₁	5.00 ±0.30
d ₁	12.00																	
d _K	20.75 ±1.04																	
d ₁	12.00																	
d _K	20.75 ±1.04																	
t ₁	2.30 ±0.30																	
d ₁	12.00																	
d _K	20.75 ±1.04																	
t ₁	5.00 ±0.30																	

Alternative thread tip types:

Secondary rough thread optional.

"RBN" with or without cutting edge	
"RBN2" with or without cutting edge	

	d ₁	d ₂	d _s
"RBN"	12.00 ±0.60	6.80 ±0.34	8.00 ±0.40
"RBN2"	12.00 ±0.60	6.80 ±0.34	8.00 ±0.40

Lengths and Thread Lengths

d ₁	L		L _G	
	min	max	min	max
12.00	120.0	600.0	48.0	160.0

Tolerance (L and L_G): according to EAD 130118-01-0603.
Intermediate lengths (L) are possible.
Intermediate thread lengths (L_G) are possible.

All dimensions in [mm].

Annex A.10

Rotho Blaas screws



CARBON STEEL
SCREWS FOR NAILING PLATES
Ø 5.0 mm

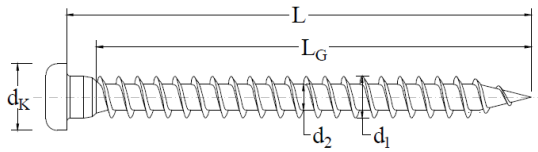

Alternative names:

LBS

Alternative head types:

Headstamps (supplier head mark and specific length) optional.

round head
with cylindrical
underhead

"RU"

d_1	5.00
d_K	7.80 ±0.50

Alternative thread tip types:

"RBP"
with or without cutting edge
with or without cut

	d_1	d_2
"RBP"	5.00 +0.00/-0.30	3.00 ±0.30

Lengths and Thread Lengths

d_1	L		L_G	
	min	max	min	max
5.00	25.0	70.0	20.0	66.0

Tolerance (L and L_G): according to EAD 130118-01-0603.
Intermediate lengths (L) are possible.
Intermediate thread lengths (L_G) are possible.

All dimensions in [mm].

CARBON STEEL
SCREWS FOR NAILING PLATES
Ø 7.0 mm

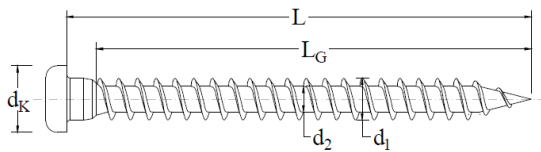

Alternative names:

LBS

Alternative head types:

Headstamps (supplier head mark and specific length) optional.

round head
with cylindrical
underhead

"RU"

d_1	7.00
d_K	11.00 ±0.60

Alternative thread tip types:

"RBP"
with or without cutting edge
with or without cut

	d_1	d_2
"RBP"	7.00 ±0.35	4.40 ±0.30

Lengths and Thread Lengths

d_1	L		L_G	
	min	max	min	max
7.00	50.0	100.0	28.0	95.0

Tolerance (L and L_G): according to EAD 130118-01-0603.
Intermediate lengths (L) are possible.
Intermediate thread lengths (L_G) are possible.

All dimensions in [mm].

Annex A.12

Rotho Blaas screws



CARBON STEEL
FULL THREAD
Ø 5.3 mm

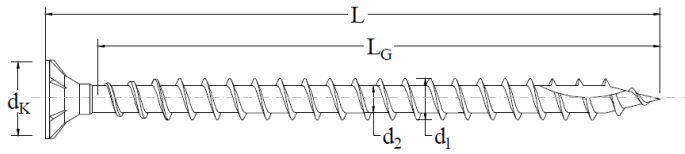

Alternative names:

VGZ/GWZ
VGS/GWS

Alternative head types:

Headstamps (supplier head mark and specific length) optional.

countersunk head with or without milling ribs under head	cylindrical head
"CS"	"CY"

d₁	5.30
d_K	11.00 ±0.60

d₁	5.30
d_K	8.00 ±0.60

Alternative thread tip types:

"RBN" with or without cutting edge	
"RBN2" with or without cutting edge	

	d₁	d₂
"RBN"	5.30 ±0.30	3.60 ±0.30
"RBN2"	5.30 ±0.30	3.60 ±0.30

Lengths and Thread Lengths

d₁	L		L_G	
	min	max	min	max
5.30	60.0	120.0	50.0	110.0

Tolerance (L and L_G): according to EAD 130118-01-0603.
Intermediate lengths (L) are possible.
Intermediate thread lengths (L_G) are possible.

All dimensions in [mm].

Annex A.13

Rotho Blaas screws



CARBON STEEL
FULL THREAD
Ø 5.6 mm

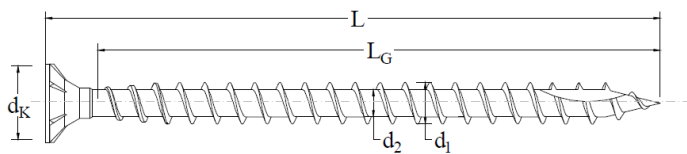

Alternative names:

VGZ/GWZ
VGS/GWS

Alternative head types:

Headstamps (supplier head mark and specific length) optional.

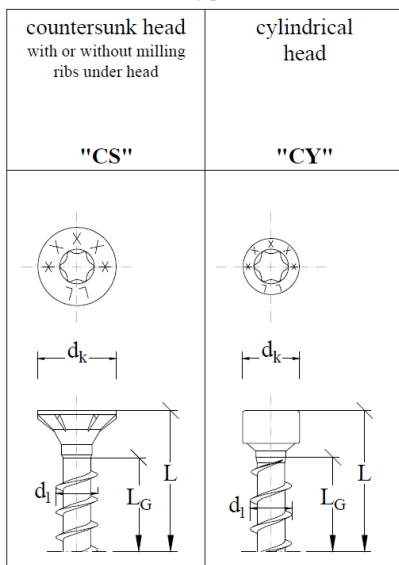

d ₁	5.60
d _K	11.00 ±0.60

d ₁	5.60
d _K	8.00 ±0.60

Alternative thread tip types:

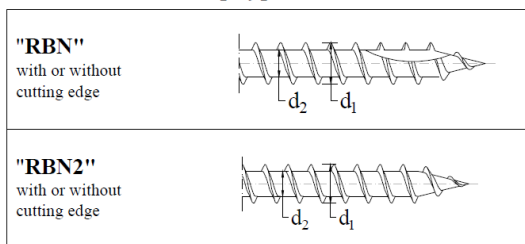

	d ₁	d ₂
"RBN"	5.60 ±0.30	3.80 ±0.30
"RBN2"	5.60 ±0.30	3.80 ±0.30

Lengths and Thread Lengths

d ₁	L		L _G	
	min	max	min	max
5.60	60.0	160.0	50.0	150.0

Tolerance (L and L_G): according to EAD 130118-01-0603.
Intermediate lengths (L) are possible.
Intermediate thread lengths (L_G) are possible.

All dimensions in [mm].

Annex A.14

Rotho Blaas screws



CARBON STEEL
FULL THREAD
Ø 7.0 mm

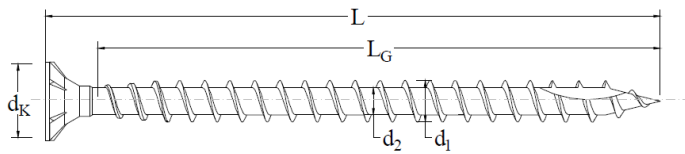

Alternative names:

VGZ/GWZ
VGS/GWS

Alternative head types:

Headstamps (supplier head mark and specific length) optional.

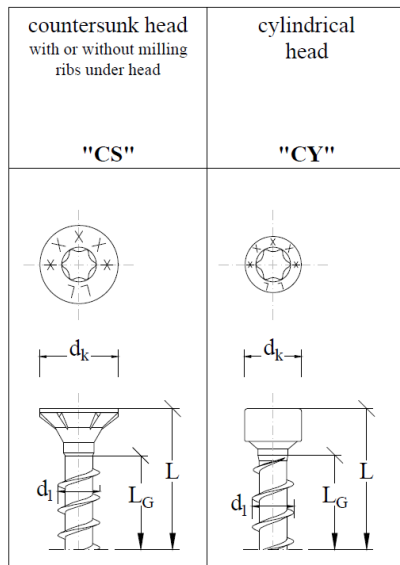

d₁	7.00
d_K	13.00 ±0.65

d₁	7.00
d_K	9.50 ±0.60

Alternative thread tip types:

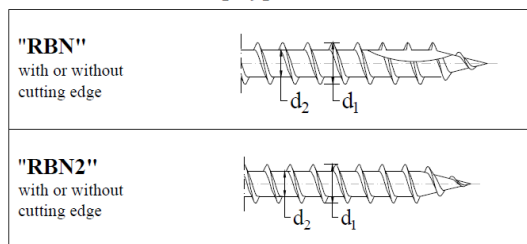

	d₁	d₂
"RBN"	7.00 ±0.35	4.60 ±0.30
"RBN2"	7.00 ±0.35	4.60 ±0.30

Lengths and Thread Lengths

d₁	L		L_G	
	min	max	min	max
7.00	60.0	400.0	50.0	390.0

Tolerance (L and L_G): according to EAD 130118-01-0603.
Intermediate lengths (L) are possible.
Intermediate thread lengths (L_G) are possible.

All dimensions in [mm].

Annex A.15

Rotho Blaas screws



CARBON STEEL
FULL THREAD
Ø 9.0 mm

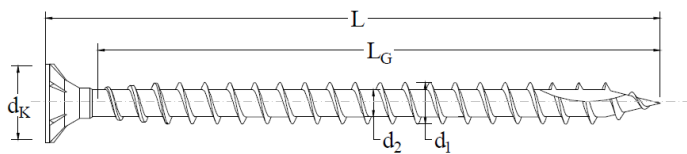

Alternative names:

VGZ/GWZ
VGS/GWS

Alternative head types:

Headstamps (supplier head mark and specific length) optional.

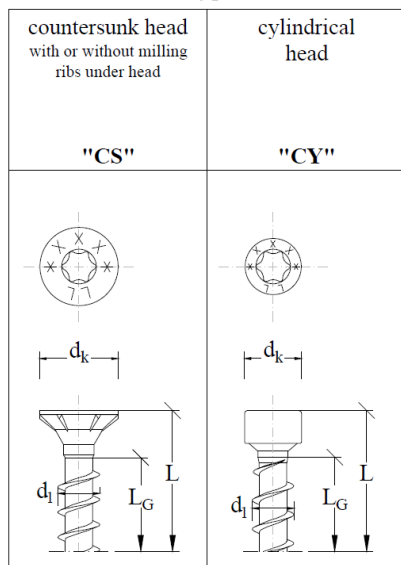

d ₁	9.00
d _K	16.00 ±0.80

d ₁	9.00
d _K	11.50 ±0.60

Alternative thread tip types:

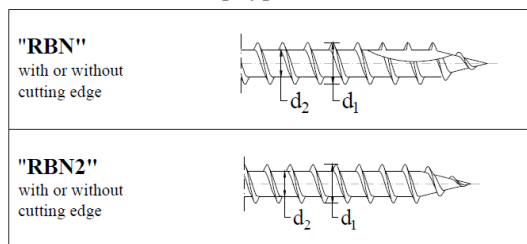

	d ₁	d ₂
"RBN"	9.00 ±0.45	5.90 ±0.30
"RBN2"	9.00 ±0.45	5.90 ±0.30

Lengths and Thread Lengths

d ₁	L		L _G	
	min	max	min	max
9.00	100.0	520.0	90.0	510.0

Tolerance (L and L_G): according to EAD 130118-01-0603.
Intermediate lengths (L) are possible.
Intermediate thread lengths (L_G) are possible.

All dimensions in [mm].

Annex A.16

Rotho Blaas screws



CARBON STEEL
FULL THREAD
Ø 11.0 mm

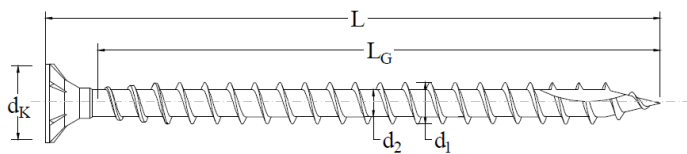

Alternative names:

VGZ/GWZ
VGS/GWS

Alternative head types:

Headstamps (supplier head mark and specific length) optional.

countersunk head with or without milling ribs under head	cylindrical head	hexagonal torx head
"CS"	"CY"	"EXA"

d₁	11.00	d₁	11.00	d₁	11.00
d_K	19.30 ±0.97	d_K	13.50 ±0.68	s	17.00 +0.00/-0.43

Alternative thread tip types:

"RBN" with or without cutting edge	
"RBN2" with or without cutting edge	
"RBSN" with or without cutting edge with or without cut	

	d₁	d₂
"RBN"	11.00 ±0.55	6.60 ±0.33
"RBN2"	11.00 ±0.55	6.60 ±0.33
"RBSN"	11.00 ±0.55	6.60 ±0.33

Lengths and Thread Lengths

d₁	L		L_G	
	min	max	min	max
11.00	100.0	600.0	80.0	590.0

Tolerance (L and L_G): according to EAD 130118-01-0603.
Intermediate lengths (L) are possible.
Intermediate thread lengths (L_G) are possible.

All dimensions in [mm].

CARBON STEEL
FULL THREAD
Ø 13.0 mm

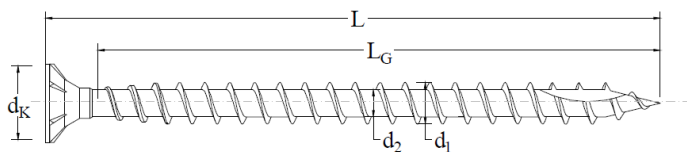

Alternative names:

VGZ/GWZ
VGS/GWS

Alternative head types:

Headstamps (supplier head mark and specific length) optional.

countersunk head with or without milling ribs under head	cylindrical head	hexagonal torx head												
"CS"	"CY"	"EXA"												
<table border="1"> <tr><td>d₁</td><td>13.00</td></tr> <tr><td>d_K</td><td>22.00 ±1.10</td></tr> </table>	d ₁	13.00	d _K	22.00 ±1.10	<table border="1"> <tr><td>d₁</td><td>13.00</td></tr> <tr><td>d_K</td><td>15.50 ±0.78</td></tr> </table>	d ₁	13.00	d _K	15.50 ±0.78	<table border="1"> <tr><td>d₁</td><td>13.00</td></tr> <tr><td>s</td><td>19.00 +0.00/-0.48</td></tr> </table>	d ₁	13.00	s	19.00 +0.00/-0.48
d ₁	13.00													
d _K	22.00 ±1.10													
d ₁	13.00													
d _K	15.50 ±0.78													
d ₁	13.00													
s	19.00 +0.00/-0.48													

Alternative thread tip types:

"RBN" with or without cutting edge	
"RBN2" with or without cutting edge	
"RBSN" with or without cutting edge with or without cut	

	d ₁	d ₂
"RBN"	13.00 ±0.65	8.00 ±0.40
"RBN2"	13.00 ±0.65	8.00 ±0.40
"RBSN"	13.00 ±0.65	8.00 ±0.40

Lengths and Thread Lengths

d ₁	L		L _G	
	min	max	min	max
13.00	100.0	1200.0	80.0	1180.0

Tolerance (L and L_G): according to EAD 130118-01-0603.
Intermediate lengths (L) are possible.
Intermediate thread lengths (L_G) are possible.

All dimensions in [mm].

CARBON STEEL
FULL THREAD
Ø 6.0 mm

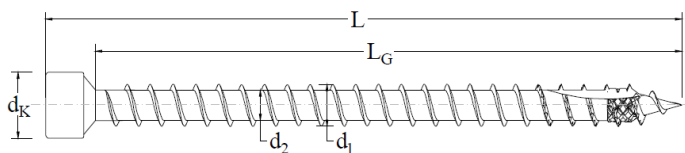

Alternative names:

VGZH / VGSH

Alternative head types:

Headstamps (supplier head mark and specific length) optional.

cylindrical head	countersunk head 60° with or without milling ribs under head								
"CY"	"CS60"								
<table border="1"> <tr><td>d₁</td><td>6.00</td></tr> <tr><td>d_K</td><td>9.50 ±0.60</td></tr> </table>	d ₁	6.00	d _K	9.50 ±0.60	<table border="1"> <tr><td>d₁</td><td>6.00</td></tr> <tr><td>d_K</td><td>12.00 ±0.60</td></tr> </table>	d ₁	6.00	d _K	12.00 ±0.60
d ₁	6.00								
d _K	9.50 ±0.60								
d ₁	6.00								
d _K	12.00 ±0.60								

Alternative thread tip types:

"RBH" with or without cutting edge with or without cut with or without saw teeth	
--	--

	d ₁	d ₂
"RBH"	6.00 ±0.30	4.50 ±0.30

Lengths and Thread Lengths

d ₁	L		L _G	
	min	max	min	max
6.00	80.0	260.0	70.0	250.0

Tolerance (L and L_G): according to EAD 130118-01-0603.
Intermediate lengths (L) are possible.
Intermediate thread lengths (L_G) are possible.

All dimensions in [mm].

CARBON STEEL
FULL THREAD
Ø 8.0 mm

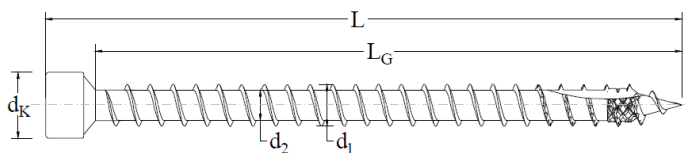

Alternative names:

VGZH / VGSH

Alternative head types:

Headstamps (supplier head mark and specific length) optional.

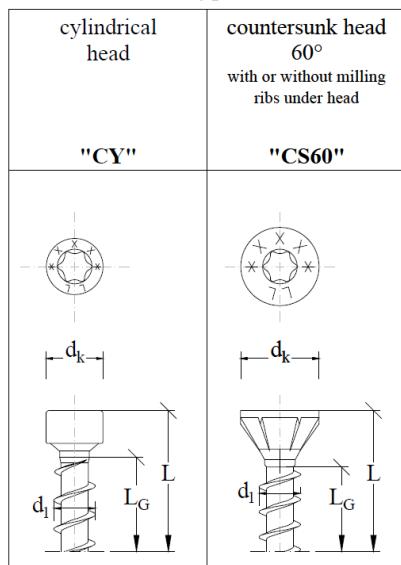

d₁	8.00
d_K	11.50 ±0.60

d₁	8.00
d_K	14.50 ±0.73

Alternative thread tip types:

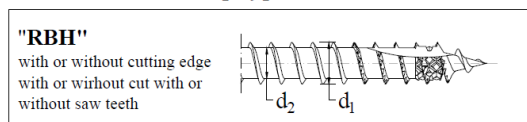

	d₁	d₂
"RBH"	8.00 ±0.40	5.90 ±0.30

Lengths and Thread Lengths

d₁	L		L_G	
	min	max	min	max
8.00	100.0	320.0	90.0	310.0

Tolerance (L and L_G): according to EAD 130118-01-0603.
Intermediate lengths (L) are possible.
Intermediate thread lengths (L_G) are possible.

All dimensions in [mm].

Annex A.20

Rotho Blaas screws



CARBON STEEL
DOUBLE THREAD
Ø 7.0 mm

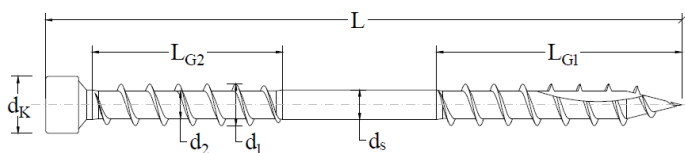

Alternative names:

DGZ/DWZ

Alternative head types:

Headstamps (supplier head mark and specific length) optional.

countersunk head with or without milling ribs under head	cylindrical head	large washer head	large washer head																
"CS"	"CY"	"LW1"	"LW2"																
<table border="1"><tr><td>d₁</td><td>7.00</td></tr><tr><td>d_K</td><td>13.00 ±0.65</td></tr></table>	d ₁	7.00	d _K	13.00 ±0.65	<table border="1"><tr><td>d₁</td><td>7.00</td></tr><tr><td>d_K</td><td>9.50 ±0.60</td></tr></table>	d ₁	7.00	d _K	9.50 ±0.60	<table border="1"><tr><td>d₁</td><td>7.00</td></tr><tr><td>d_K</td><td>17.50 ±0.88</td></tr></table>	d ₁	7.00	d _K	17.50 ±0.88	<table border="1"><tr><td>d₁</td><td>7.00</td></tr><tr><td>d_K</td><td>17.50 ±0.88</td></tr></table>	d ₁	7.00	d _K	17.50 ±0.88
d ₁	7.00																		
d _K	13.00 ±0.65																		
d ₁	7.00																		
d _K	9.50 ±0.60																		
d ₁	7.00																		
d _K	17.50 ±0.88																		
d ₁	7.00																		
d _K	17.50 ±0.88																		

Alternative thread tip types:

"RBN" with or without cutting edge	
"RBN2" with or without cutting edge	

	d ₁	d ₂	d _s
"RBN"	7.00 ±0.35	4.60 ±0.30	5.00 ±0.30
"RBN2"	7.00 ±0.35	4.60 ±0.30	5.00 ±0.30

Lengths and Thread Lengths

d ₁	L		L _{G1}		L _{G2}	
	min	max	min	max	min	max
7.00	220.0	400.0	40.0	100.0	40.0	80.0

Tolerance (L, L_{G1} and L_{G2}): according to EAD 130118-01-0603.
Intermediate lengths (L) are possible.
Intermediate thread lengths (L_G) are possible.

All dimensions in [mm].

Annex A.21

Rotho Blaas screws



CARBON STEEL
DOUBLE THREAD
Ø 9.0 mm

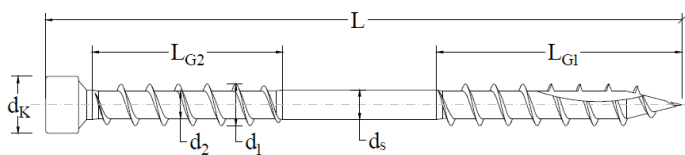

Alternative names:

DGZ/DWZ

Alternative head types:

Headstamps (supplier head mark and specific length) optional.

countersunk head with or without milling ribs under head	cylindrical head	large washer head	large washer head																
"CS"	"CY"	"LW1"	"LW2"																
<table border="1"><tr><td>d₁</td><td>9.00</td></tr><tr><td>d_K</td><td>16.00 ±0.80</td></tr></table>	d ₁	9.00	d _K	16.00 ±0.80	<table border="1"><tr><td>d₁</td><td>9.00</td></tr><tr><td>d_K</td><td>11.50 ±0.60</td></tr></table>	d ₁	9.00	d _K	11.50 ±0.60	<table border="1"><tr><td>d₁</td><td>9.00</td></tr><tr><td>d_K</td><td>22.00 ±1.10</td></tr></table>	d ₁	9.00	d _K	22.00 ±1.10	<table border="1"><tr><td>d₁</td><td>9.00</td></tr><tr><td>d_K</td><td>22.00 ±1.10</td></tr></table>	d ₁	9.00	d _K	22.00 ±1.10
d ₁	9.00																		
d _K	16.00 ±0.80																		
d ₁	9.00																		
d _K	11.50 ±0.60																		
d ₁	9.00																		
d _K	22.00 ±1.10																		
d ₁	9.00																		
d _K	22.00 ±1.10																		

Alternative thread tip types:

"RBN" with or without cutting edge	
"RBN2" with or without cutting edge	

	d ₁	d ₂	d _s
"RBN"	9.00 ±0.45	5.90 ±0.30	6.50 ±0.33
"RBN2"	9.00 ±0.45	5.90 ±0.30	6.50 ±0.33

Lengths and Thread Lengths

d ₁	L		L _{G1}		L _{G2}	
	min	max	min	max	min	max
9.00	220.0	520.0	40.0	100.0	40.0	80.0

Tolerance (L, L_{G1} and L_{G2}): according to EAD 130118-01-0603.
Intermediate lengths (L) are possible.
Intermediate thread lengths (L_G) are possible.

All dimensions in [mm].

Annex A.22

Rotho Blaas screws



STAINLESS STEEL
PARTIAL THREAD
Ø 3.5 mm

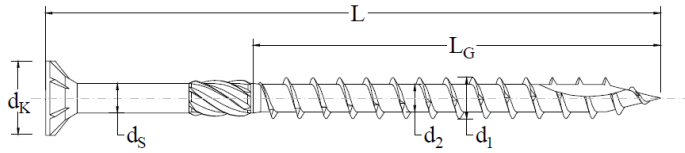

Alternative names:
SCI

Alternative head types:

Headstamps (supplier head mark and specific length) optional.

countersunk head
with or without milling
ribs under head

"CS"

d_1	3.50
d_K	7.00 ±0.50

Alternative thread tip types:

Secondary rough thread optional.

"RBN"
with or without
cutting edge

"RBN2"
with or without
cutting edge

	d_1	d_2	d_s
"RBN"	3.50 ±0.30	2.25 ±0.30	2.45 ±0.30
"RBN2"	3.50 ±0.30	2.25 ±0.30	2.45 ±0.30

Lengths and Thread Lengths

d_1	L		L_G	
	min	max	min	max
3.50	20.0	50.0	14.0	24.0

Tolerance (L and L_G): according to EAD 130118-01-0603.
Intermediate lengths (L) are possible.
Intermediate thread lengths (L_G) are possible.

All dimensions in [mm].

STAINLESS STEEL
PARTIAL THREAD
Ø 4.0 mm

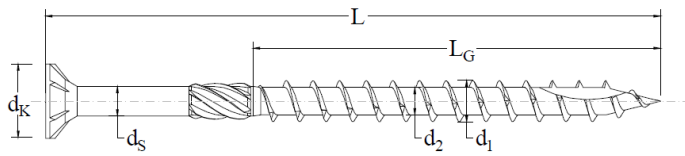

Alternative names:

SCI

Alternative head types:

Headstamps (supplier head mark and specific length) optional.

countersunk head
with or without milling
ribs under head

"CS"

d_1	4.00
d_K	8.00 ±0.60

Alternative thread tip types:

Secondary rough thread optional.

"RBN"
with or without
cutting edge

"RBN2"
with or without
cutting edge

	d_1	d_2	d_s
"RBN"	4.00 ±0.30	2.55 ±0.30	2.75 ±0.30
"RBN2"	4.00 ±0.30	2.55 ±0.30	2.75 ±0.30

Lengths and Thread Lengths

d_1	L		L_G	
	min	max	min	max
4.00	20.0	60.0	16.0	40.0

Tolerance (L and L_G): according to EAD 130118-01-0603.
Intermediate lengths (L) are possible.
Intermediate thread lengths (L_G) are possible.

All dimensions in [mm].

STAINLESS STEEL
PARTIAL THREAD
Ø 4.5 mm

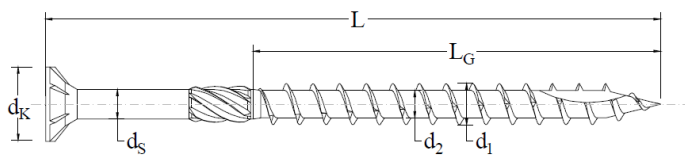

Alternative names:

SCI

Alternative head types:

Headstamps (supplier head mark and specific length) optional.

countersunk head
with or without milling
ribs under head

"CS"

d_1	4.50
d_K	9.00 ±0.60

Alternative thread tip types:

Secondary rough thread optional.

"RBN"
with or without
cutting edge

"RBN2"
with or without
cutting edge

	d_1	d_2	d_s
"RBN"	4.50 ±0.30	2.80 ±0.30	3.15 ±0.30
"RBN2"	4.50 ±0.30	2.80 ±0.30	3.15 ±0.30

Lengths and Thread Lengths

d_1	L		L_G	
	min	max	min	max
4.50	35.0	80.0	18.0	40.0

Tolerance (L and L_G): according to EAD 130118-01-0603.
Intermediate lengths (L) are possible.
Intermediate thread lengths (L_G) are possible.

All dimensions in [mm].

Annex A.25

Rotho Blaas screws



STAINLESS STEEL
PARTIAL THREAD
Ø 5.0 mm

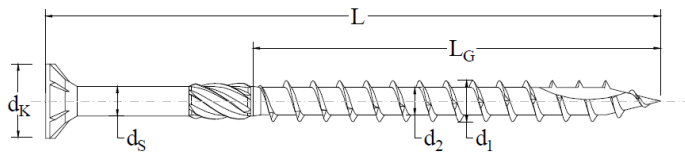

Alternative names:

SCI

Alternative head types:

Headstamps (supplier head mark and specific length) optional.

countersunk head
with or without milling
ribs under head

"CS"

d_1	5.00
d_K	10.00 ±0.60

Alternative thread tip types:

Secondary rough thread optional.

"RBN"
with or without
cutting edge

"RBN2"
with or without
cutting edge

	d_1	d_2	d_s
"RBN"	5.00 ±0.30	3.40 ±0.30	3.65 ±0.30
"RBN2"	5.00 ±0.30	3.40 ±0.30	3.65 ±0.30

Lengths and Thread Lengths

d_1	L		L_G	
	min	max	min	max
5.00	40.0	100.0	20.0	50.0

Tolerance (L and L_G): according to EAD 130118-01-0603.
Intermediate lengths (L) are possible.
Intermediate thread lengths (L_G) are possible.

All dimensions in [mm].

STAINLESS STEEL
PARTIAL THREAD
Ø 6.0 mm

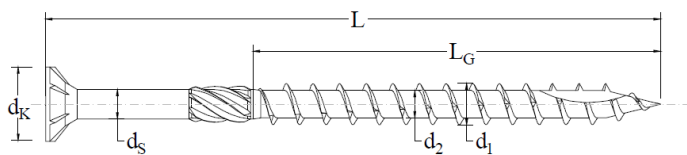

Alternative names:

SCI

Alternative head types:

Headstamps (supplier head mark and specific length) optional.

countersunk head
with or without milling
ribs under head

"CS"

d_1	6.00
d_K	12.00 ±0.60

Alternative thread tip types:

Secondary rough thread optional.

"RBN"
with or without
cutting edge

"RBN2"
with or without
cutting edge

	d_1	d_2	d_s
"RBN"	6.00 ±0.30	3.95 ±0.30	4.30 ±0.30
"RBN2"	6.00 ±0.30	3.95 ±0.30	4.30 ±0.30

Lengths and Thread Lengths

d_1	L		L_G	
	min	max	min	max
6.00	50.0	300.0	24.0	75.0

Tolerance (L and L_G): according to EAD 130118-01-0603.
Intermediate lengths (L) are possible.
Intermediate thread lengths (L_G) are possible.

All dimensions in [mm].

STAINLESS STEEL
PARTIAL THREAD
Ø 8.0 mm

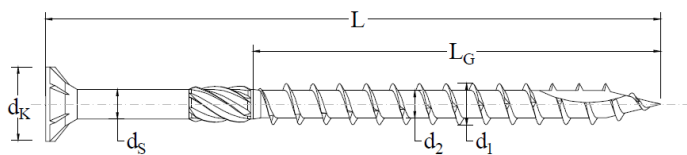

Alternative names:

SCI

Alternative head types:

Headstamps (supplier head mark and specific length) optional.

countersunk head
with or without milling
ribs under head

"CS"

d_1	8.00
d_K	14.50 ±0.73

Alternative thread tip types:

Secondary rough thread optional.

"RBN"
with or without
cutting edge

"RBN2"
with or without
cutting edge

	d_1	d_2	d_s
"RBN"	8.00 ±0.40	5.40 ±0.30	5.80 ±0.30
"RBN2"	8.00 ±0.40	5.40 ±0.30	5.80 ±0.30

Lengths and Thread Lengths

d_1	L		L_G	
	min	max	min	max
8.00	40.0	280.0	32.0	100.0

Tolerance (L and L_G): according to EAD 130118-01-0603.
Intermediate lengths (L) are possible.
Intermediate thread lengths (L_G) are possible.

All dimensions in [mm].

Annex A.28

Rotho Blaas screws



STAINLESS STEEL
PARTIAL THREAD
Ø 4.0 mm

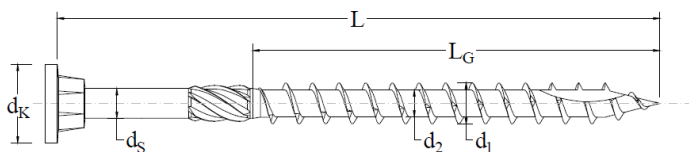

Alternative names:

KKF/KGA/GHKF

Alternative head types:

Headstamps (supplier head mark and specific length) optional.

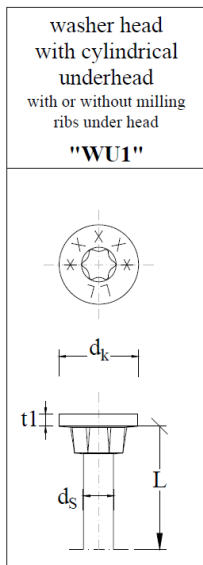

d_1	4.00
d_k	7.70 ±0.50
t_1	1.00 ±0.30

Alternative thread tip types:

Secondary rough thread optional.

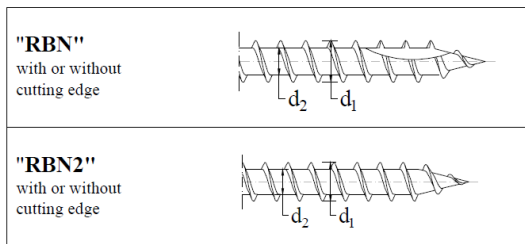

	d_1	d_2	d_s
"RBN"	4.00 ±0.30	2.60 ±0.30	2.90 ±0.30
"RBN2"	4.00 ±0.30	2.60 ±0.30	2.90 ±0.30

Lengths and Thread Lengths

d_1	L		L_G	
	min	max	min	max
4.00	30.0	80.0	16.0	40.0

Tolerance (L and L_G): according to EAD 130118-01-0603.
Intermediate lengths (L) are possible.
Intermediate thread lengths (L_G) are possible.

All dimensions in [mm].

Annex A.29

Rotho Blaas screws



STAINLESS STEEL
PARTIAL THREAD
Ø 4.5 mm

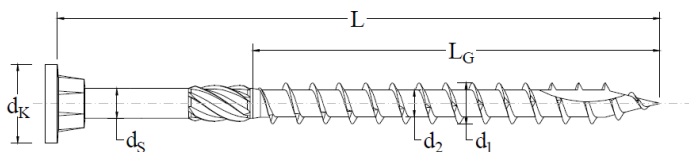

Alternative names:

KKF/KGA/GHKF

Alternative head types:

Headstamps (supplier head mark and specific length) optional.

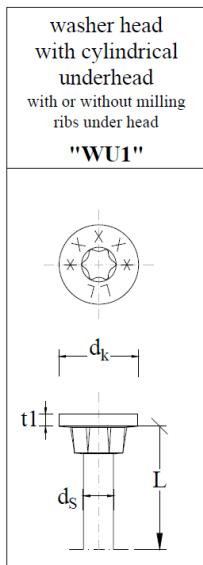

d₁	4.50
d_k	8.70 ±0.60
t₁	1.00 ±0.30

Alternative thread tip types:

Secondary rough thread optional.

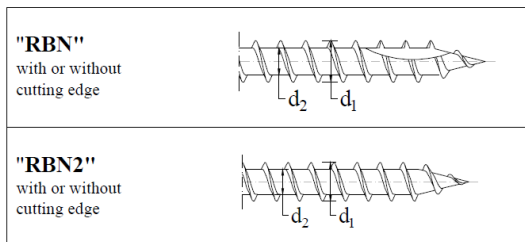

	d₁	d₂	d_s
"RBN"	4.50 ±0.30	3.05 ±0.30	3.35 ±0.30
"RBN2"	4.50 ±0.30	3.05 ±0.30	3.35 ±0.30

Lengths and Thread Lengths

d₁	L		L_G	
	min	max	min	max
4.50	20.0	80.0	18.0	40.0

Tolerance (L and L_G): according to EAD 130118-01-0603.
Intermediate lengths (L) are possible.
Intermediate thread lengths (L_G) are possible.

All dimensions in [mm].

Annex A.30

Rotho Blaas screws



STAINLESS STEEL
PARTIAL THREAD
Ø 5.0 mm

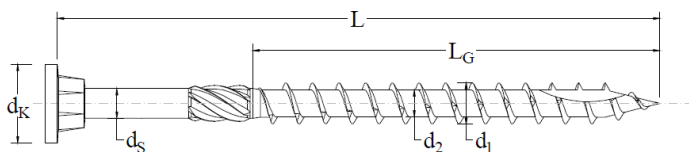

Alternative names:

KKF/KGA/GHKF

Alternative head types:

Headstamps (supplier head mark and specific length) optional.

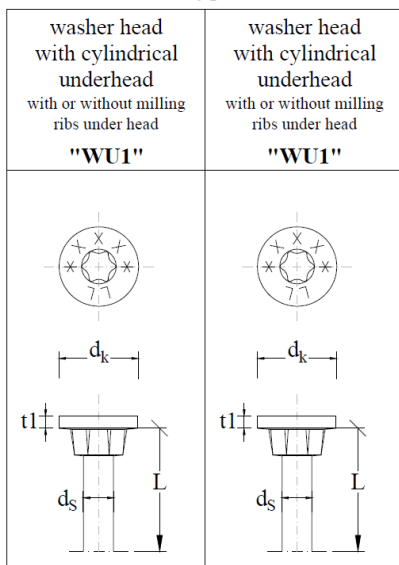

d ₁	5.00
d _K	8.70 ±0.60
t ₁	1.00 ±0.30

d ₁	5.00
d _K	9.65 ±0.60
t ₁	1.00 ±0.30

Alternative thread tip types:

Secondary rough thread optional.

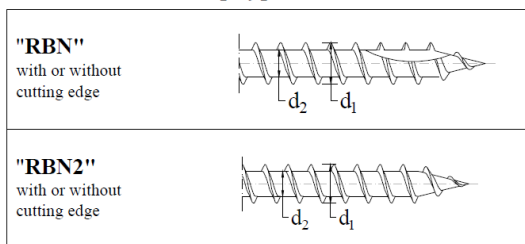

	d ₁	d ₂	d _S
"RBN"	5.00 ±0.30	3.25 ±0.30	3.60 ±0.30
"RBN2"	5.00 ±0.30	3.25 ±0.30	3.60 ±0.30

Lengths and Thread Lengths

d ₁	L		L _G	
	min	max	min	max
5.00	40.0	120.0	20.0	60.0

Tolerance (L and L_G): according to EAD 130118-01-0603.
Intermediate lengths (L) are possible.
Intermediate thread lengths (L_G) are possible.

All dimensions in [mm].

STAINLESS STEEL
PARTIAL THREAD
Ø 6.0 mm

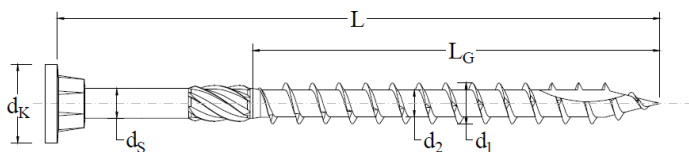

Alternative names:

KKF/KGA/GHKF

Alternative head types:

Headstamps (supplier head mark and specific length) optional.

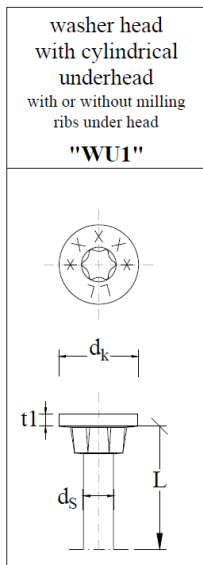

d₁	6.00
d_k	11.65 ±0.60
t₁	1.00 ±0.30

Alternative thread tip types:

Secondary rough thread optional.

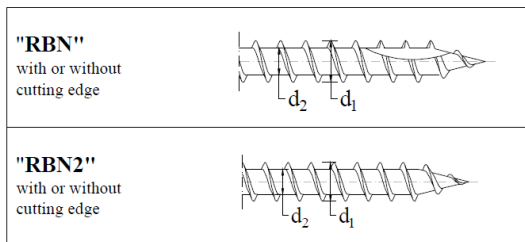

	d₁	d₂	d_s
"RBN"	6.00 ±0.30	4.05 ±0.30	4.30 ±0.30
"RBN2"	6.00 ±0.30	4.05 ±0.30	4.30 ±0.30

Lengths and Thread Lengths

d₁	L		L_G	
	min	max	min	max
6.00	60.0	300.0	24.0	100.0

Tolerance (L and L_G): according to EAD 130118-01-0603.
Intermediate lengths (L) are possible.
Intermediate thread lengths (L_G) are possible.

All dimensions in [mm].

STAINLESS STEEL
PARTIAL THREAD
Ø 8.0 mm

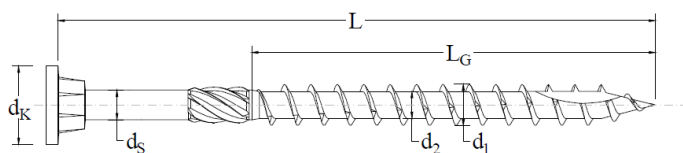

Alternative names:

KKF/KGA/GHKF

Alternative head types:

Headstamps (supplier head mark and specific length) optional.

washer head with cylindrical underhead with or without milling ribs under head "WU1"	washer head with cylindrical underhead with or without milling ribs under head "WU2"	countersunk head with or without milling ribs under head "CS"																
<table border="1"><tr><td>d₁</td><td>8.00</td></tr><tr><td>d_K</td><td>14.50 ±0.73</td></tr><tr><td>t₁</td><td>1.75 ±0.30</td></tr></table>	d ₁	8.00	d _K	14.50 ±0.73	t ₁	1.75 ±0.30	<table border="1"><tr><td>d₁</td><td>8.00</td></tr><tr><td>d_K</td><td>14.50 ±0.73</td></tr><tr><td>t₁</td><td>3.40 ±0.30</td></tr></table>	d ₁	8.00	d _K	14.50 ±0.73	t ₁	3.40 ±0.30	<table border="1"><tr><td>d₁</td><td>8.00</td></tr><tr><td>d_K</td><td>14.50 ±0.73</td></tr></table>	d ₁	8.00	d _K	14.50 ±0.73
d ₁	8.00																	
d _K	14.50 ±0.73																	
t ₁	1.75 ±0.30																	
d ₁	8.00																	
d _K	14.50 ±0.73																	
t ₁	3.40 ±0.30																	
d ₁	8.00																	
d _K	14.50 ±0.73																	

Alternative thread tip types:

Secondary rough thread optional.

"RBN" with or without cutting edge	
"RBN2" with or without cutting edge	

	d ₁	d ₂	d _s
"RBN"	8.00 ±0.40	5.40 ±0.30	5.80 ±0.30
"RBN2"	8.00 ±0.40	5.40 ±0.30	5.80 ±0.30

Lengths and Thread Lengths

d ₁	L		L _G	
	min	max	min	max
8.00	60.0	320.0	24.0	100.0

Tolerance (L and L_G): according to EAD 130118-01-0603.
Intermediate lengths (L) are possible.
Intermediate thread lengths (L_G) are possible.

All dimensions in [mm].

CARBON STEEL
 THREADED ROD
 Ø 16.0 mm

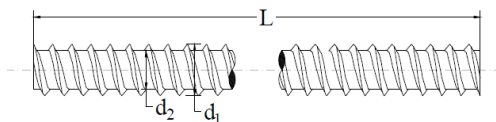

Alternative names:

RTR

Alternative thread tip types:

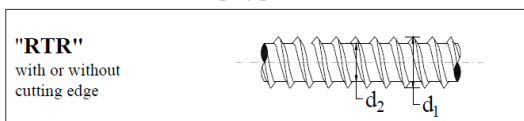

Stamps (supplier head mark and specific length) optional.

	d ₁	d ₂
"RTR"	16.00 ±0.80	12.00 ±0.60

Lengths

d ₁	L	
	min	max
16.00	100.0	3000.0

Tolerance (L): according to EAD 130118-01-0603.
 Intermediate lengths (L) are possible.

All dimensions in [mm].

CARBON STEEL
THREADED ROD
Ø 20.0 mm

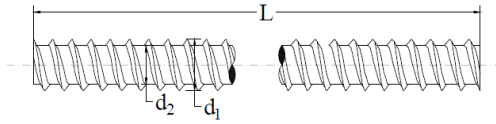

Alternative names:

RTR

Alternative thread tip types:

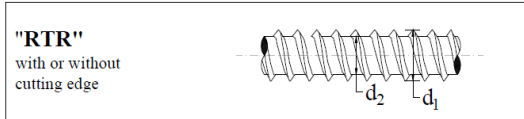

Stamps (supplier head mark and specific length) optional.

	d ₁	d ₂
"RTR"	20.00 ±1.00	15.00 ±0.75

Lengths

d ₁	L	
	min	max
20.00	100.0	3000.0

Tolerance (L): according to EAD 130118-01-0603.
Intermediate lengths (L) are possible.

All dimensions in [mm].

CARBON OR STAINLESS STEEL
TERRACE SCREW
Ø 5.0 mm

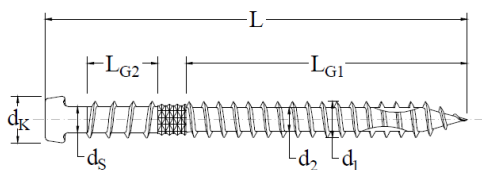

Alternative names:

KKT/MN

Alternative head types:

Headstamps (supplier head mark and specific length) optional.

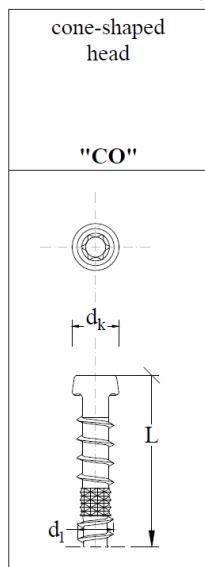

d_1	5.00
d_K	6.75 ±0.50

Alternative thread tip types:

Secondary rough thread (knurled part) optional.

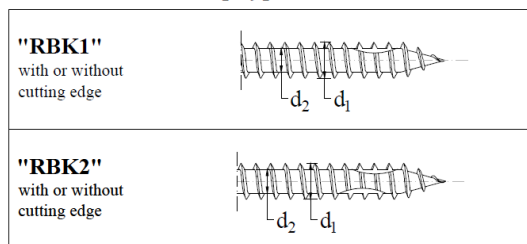

	d_1	d_2	d_s
"RBK1"	5.00 ±0.30	3.10 ±0.30	3.80 ±0.30
"RBK2"	5.00 ±0.30	3.10 ±0.30	3.80 ±0.30

Lengths and Thread Lengths

d_1	L		L_{G1}		L_{G2}	
	min	max	min	max	min	max
5.00	40.0	80.0	20.0	53.0	10.0	12.0

Tolerance (L, L_{G1} and L_{G2}): according to EAD 130118-01-0603.
Intermediate lengths (L) are possible.
Intermediate thread lengths (L_G) are possible.

All dimensions in [mm].

CARBON OR STAINLESS STEEL
TERRACE SCREW
Ø 5.0 mm

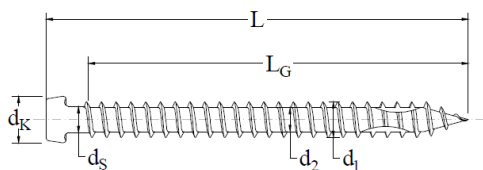

Alternative names:

KKT/MN

Alternative head types:

Headstamps (supplier head mark and specific length) optional.

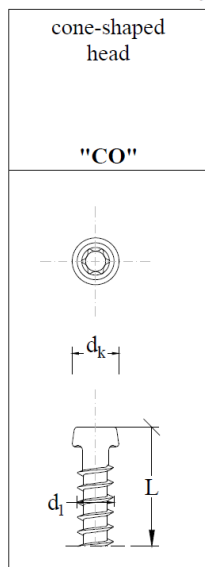

d_1	5.00
d_K	6.75 ±0.50

Alternative thread tip types:

Secondary rough thread (knurled part) optional.

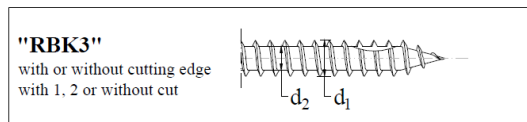

	d_1	d_2	d_s
"RBK3"	5.00 ±0.30	3.10 ±0.30	3.80 ±0.30

Lengths and Thread Lengths

d_1	L		L_G	
	min	max	min	max
5.00	24.0	80.0	20.0	53.0

Tolerance (L and L_G): according to EAD 130118-01-0603.
Intermediate lengths (L) are possible.
Intermediate thread lengths (L_G) are possible.

All dimensions in [mm].

CARBON OR STAINLESS STEEL
TERRACE SCREW
Ø 6.0 mm

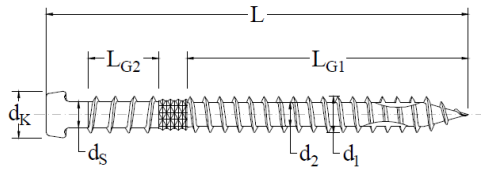

Alternative names:

KKT/MN

Alternative head types:

Headstamps (supplier head mark and specific length) optional.

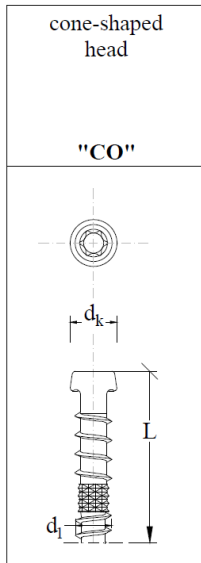

d_1	6.00
d_K	7.75 ±0.50

Alternative thread tip types:

Secondary rough thread (knurled part) optional.

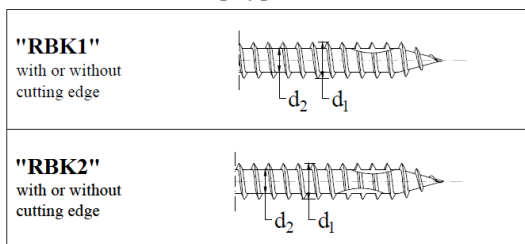

	d_1	d_2	d_s
"RBK1"	6.00 ±0.30	3.90 ±0.30	4.50 ±0.30
"RBK2"	6.00 ±0.30	3.90 ±0.30	4.50 ±0.30

Lengths and Thread Lengths

d_1	L		L_{G1}		L_{G2}	
	min	max	min	max	min	max
6.00	60.0	120.0	24.0	60.0	12.0	26.0

Tolerance (L, L_{G1} and L_{G2}): according to EAD 130118-01-0603.
Intermediate lengths (L) are possible.
Intermediate thread lengths (L_G) are possible.

All dimensions in [mm].

Annex A.38

Rotho Blaas washers



CARBON STEEL OR STAINLESS STEEL
COUNTERSUNK WASHER
 $\varnothing 6.0 \div 12.0$ mm

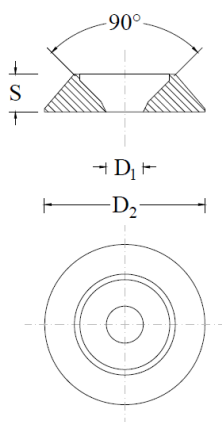

Alternative names:

HUS/SUS/SCB/SHT

Headstamps (supplier head mark and specific length) optional.

D_1	D_2	S
7.50 ± 0.38	20.00 ± 1.00	4.60 ± 0.30
8.50 ± 0.43	25.00 ± 1.25	5.40 ± 0.30
10.80 ± 0.54	30.00 ± 1.50	6.40 ± 0.33
13.00 ± 0.65	35.00 ± 1.75	7.50 ± 0.38
14.00 ± 0.70	37.00 ± 1.85	8.50 ± 0.43

Intermediate sizes are possible.

All dimensions in [mm].

Annex A.39

Rotho Blaas washers



CARBON STEEL
COUNTERSUNK WASHER 45°
Ø 9.0 ÷ 13.0 mm

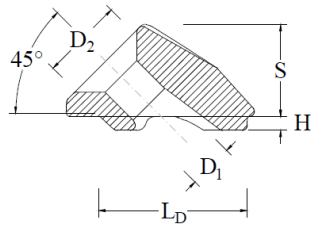

Alternative names:

VGU

Headstamps (supplier head mark and specific length) optional.

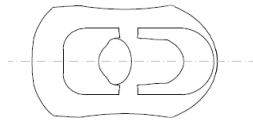

D_1	D_2	S	H	L_D
9.70 ±0.49	19.00 ±0.95	20.00 ±1.00	3.00 ±0.30	31.80 ±1.50
11.80 ±0.59	23.00 ±1.15	24.40 ±1.22	3.60 ±0.30	38.80 ±1.50
14.00 ±0.70	27.40 ±1.37	28.70 ±1.44	4.30 ±0.30	45.80 ±1.50

Intermediate sizes are possible.

All dimensions in [mm].

Annex B

Minimum distances and spacing

Axially loaded screws or threaded rods Single configuration

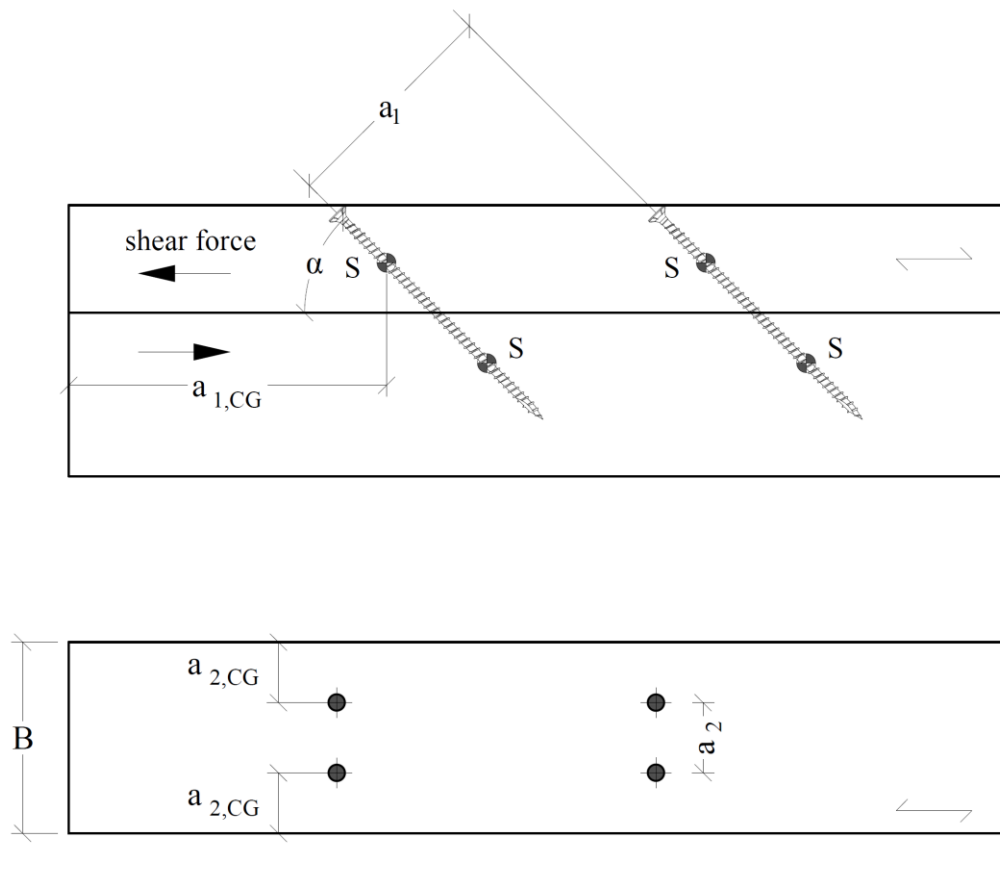

$$a_1 \geq 5 \cdot d$$

$$a_2 \geq 2,5 \cdot d \quad \text{if } a_1 \cdot a_2 \geq 25 \cdot d^2$$

$$a_{3,c} \geq 10 \cdot d$$

$$a_{4,c} \geq 4 \cdot d$$

Minimum distances and spacing see also 3.12

Minimum timber thickness $t = 12 \cdot d$, see also 3.12

S = centroid of the part of the screw or threaded rod in the timber

Axially loaded screws or threaded rods
Crosswise configuration

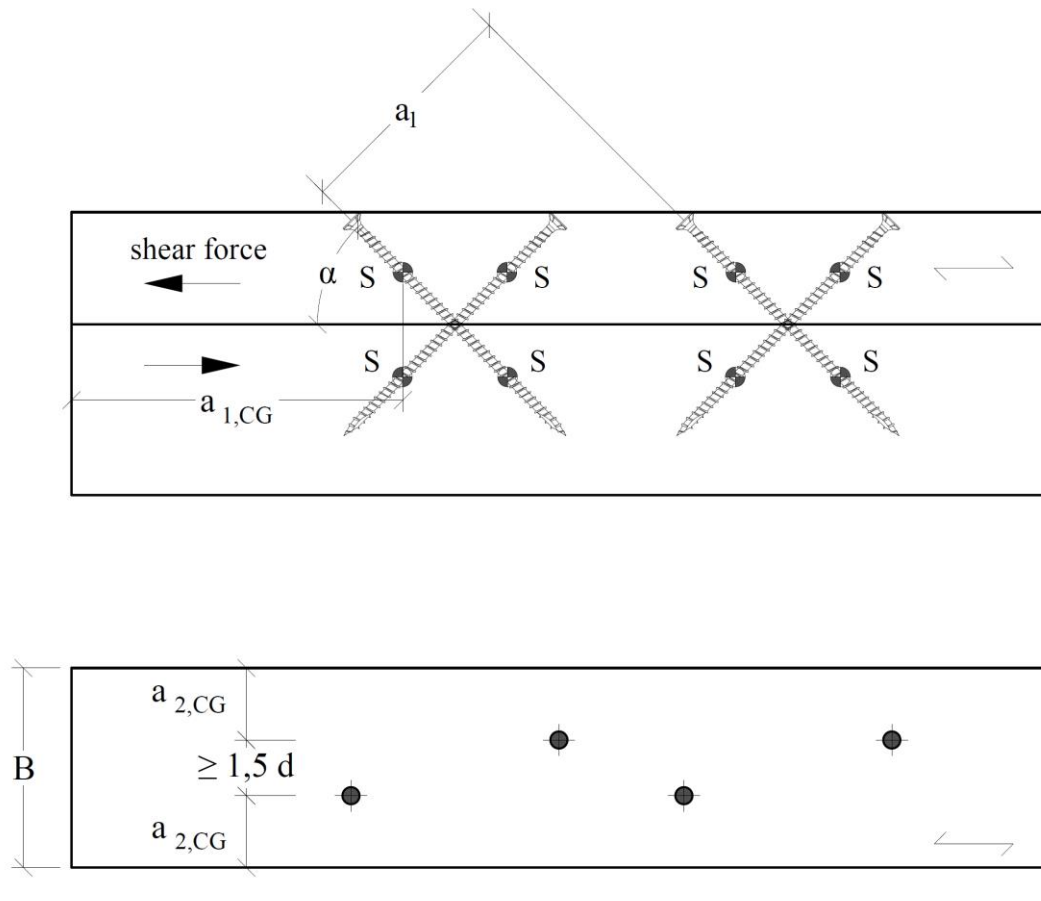

$$\begin{aligned}
 a_1 &\geq 5 \cdot d \\
 a_2 &\geq 1,5 \cdot d \quad \text{if } a_1 \cdot a_2 \geq 25 \cdot d^2 \\
 a_{3,c} &\geq 10 \cdot d \\
 a_{4,c} &\geq 4 \cdot d
 \end{aligned}$$

Minimum distances and spacing see also 3.12

Minimum timber thickness $t = 12 \cdot d$, see also 3.12

S = centroid of the part of the screw or threaded rod in the timber

Axially or laterally loaded screws or threaded rods in the plane or edge surface of cross laminated timber

Definition of spacing, end and edge distances in the plane surface unless otherwise specified in the technical specification (ETA or hEN) for the cross laminated timber:

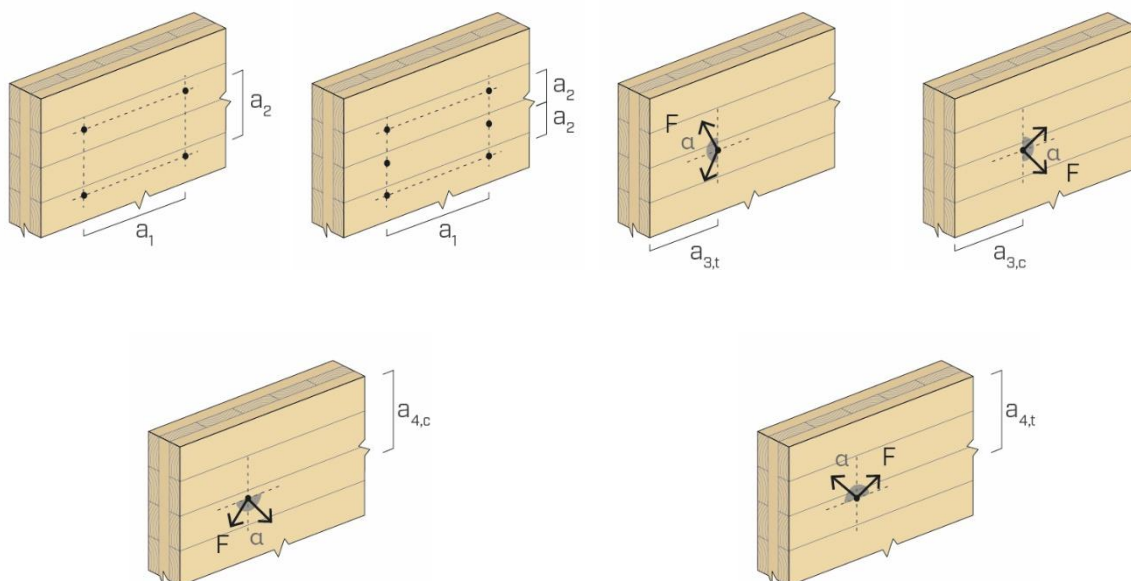

Note. Drawing is copyright Rotho Blaas

Definition of spacing, end and edge distances in the edge surface unless otherwise specified in the technical specification (ETA or hEN) for the cross laminated timber:

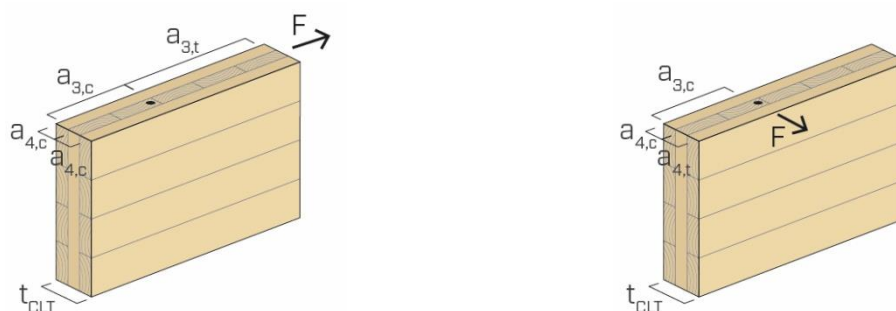

Note. Drawing is copyright Rotho Blaas

Table B1: Minimum spacing, end and edge distances of screws or threaded rods in the plane or edge surfaces of cross laminated timber

	a_1	$a_{3,t}$	$a_{3,c}$	a_2	$a_{4,t}$	$a_{4,c}$
Plane surface (see Figure 1)	$4 \cdot d$	$6 \cdot d$	$6 \cdot d$	$2,5 \cdot d$	$6 \cdot d$	$2,5 \cdot d$
Edge surface (see Figure 2)	$10 \cdot d$	$12 \cdot d$	$7 \cdot d$	$4 \cdot d$	$6 \cdot d$	$3 \cdot d$

Annex C Compression reinforcement

“VGS”, “VGZ”, “VGZH” and “VGSH” screws with a full thread or “RTR” threaded rods may be used for reinforcement of timber members with compression stresses at an angle α to the grain of $45^\circ < \alpha < 90^\circ$. The compression force must be evenly distributed over all screws or threaded rods.

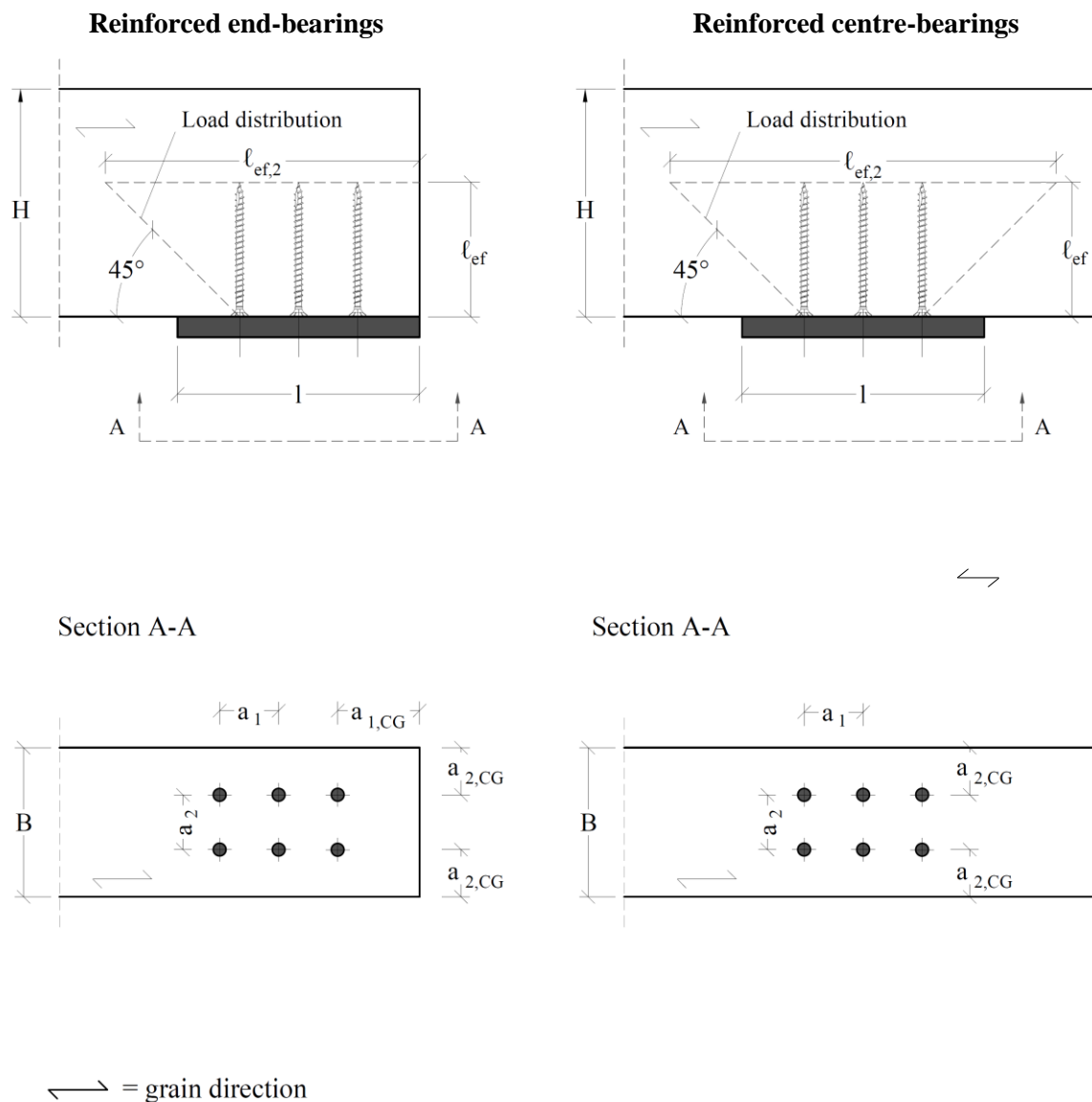

The design load-carrying capacity for a reinforced contact area with screws with a full thread or threaded rods at an angle α to the grain of $45^\circ < \alpha < 90^\circ$ shall be calculated from:

$$F_{90,Rd} = \min \left\{ \begin{array}{l} k_{c,90} \cdot B \cdot l_{ef,1} \cdot f_{c,90,d} + n \cdot F_{c,90,Rd} \\ B \cdot l_{ef,2} \cdot f_{c,90,d} \end{array} \right.$$

Where:

- $F_{90,Rd}$ design load-carrying capacity of reinforced contact area [N]
- $k_{c,90}$ factor for compression perpendicular to the grain according to EN 1995-1-1, 6.1.5
- B bearing width [mm]
- H component height [mm]
- $l_{ef,1}$ effective length of contact area according to EN 1995-1-1, 6.1.5 [mm]
- $f_{c,90,d}$ design compressive strength perpendicular to the grain [N/mm²]
- n number of reinforcement fasteners, $n = n_0 \cdot n_{90}$
- n_0 number of reinforcement fasteners arranged in a row parallel to the grain
- n_{90} number of reinforcement fasteners arranged in a row perpendicular to the grain

$l_{ef,2}$	effective distribution length in the plane of the fastener tips [mm]
$l_{ef,2}$	$= 2 \cdot l_{ef} + (n_0 - 1) \cdot a_1$ for reinforced centre-bearings
$l_{ef,2}$	$= l_{ef} + (n_0 - 1) \cdot a_1 + \min(l_{ef}, a_{1,c})$ for reinforced end-bearings
l_{ef}	point side penetration length [mm]
a_1	spacing parallel to grain [mm]
$a_{1,CG}$	end grain distance of the centre of the screw-part in timber [mm]
$F_{c,90,Rd}$	design compressive capacity [N]

An appropriate steel plate as intermediate layer between timber member and support has to be installed. The screws have to be driven into the timber member flush with the surface to provide both direct contact with the steel plate and direct contact between steel plate and timber.

Reinforcing screws or threaded rods for wood-based panels are not covered by this European Technical Assessment.

Annex D
Thermal insulation material on top of rafters or facades

Rotho Blaas screws with an outer thread diameter of at least 6 mm may also be used for the fixing of thermal insulation on top of rafters.

The thickness of the insulation shall not exceed 400 mm. The rafter insulation must be placed on top of solid timber or glued laminated timber rafters or cross laminated timber members and be fixed by battens arranged parallel to the rafters or by wood-based panels on top of the insulation layer. The insulation of vertical facades is also covered by the rules given here.

Screws must be screwed in the rafter through the battens or panels and the insulation without pre-drilling in one sequence.

The angle α between the screw axis and the grain direction of the rafter should be between 30° and 90° .

The rafter consists of solid timber (softwood) according to EN 338 or EN 14081, glued laminated timber according to EN 14081, cross-laminated timber, or laminated veneer lumber according to EN 14374 or to ETA or similar glued members according to ETA.

The battens must be from solid timber (softwood) according to EN 338:2003-04 or EN 14081. The minimum thickness t and the minimum width b of the battens is given as follows:

Screws $d \leq 8$ mm:	$b_{\min} = 50$ mm	$t_{\min} = 30$ mm
Screws $9 \leq d \leq 10$ mm:	$b_{\min} = 60$ mm	$t_{\min} = 40$ mm
Screws $d = 11$ mm:	$b_{\min} = 80$ mm	$t_{\min} = 60$ mm
Screws $12 \leq d \leq 13$ mm:	$b_{\min} = 100$ mm	$t_{\min} = 80$ mm

Alternatively to the battens, boards with a minimum thickness of 20 mm from plywood according to EN 636, particle board according to EN 312, oriented strand board OSB/3 and OSB/4 according to EN 300, solid wood panels according to EN 13353 or to ETA or national provision that apply at the installation site or cross laminated timber according to ETA may be used.

The insulation must comply with a European Technical Specification.

Friction forces shall not be considered for the design of the characteristic axial capacity of the screws.

The anchorage of wind suction forces as well as the bending stresses of the battens or the boards, respectively, shall be considered in design. Additional screws perpendicular to the grain of the rafter (angle $\alpha = 90^\circ$) may be arranged if necessary.

The maximum screw spacing is $e_s = 1,75$ m.

Thermal insulation on rafters with parallel inclined screws

Mechanical model

The system of rafter, thermal insulation material on top of rafter and battens parallel to the rafter may be considered as a beam on elastic foundation. The batten represents the beam, and the thermal insulation material on top of the rafter the elastic foundation. The minimum compression stress of the thermal insulation material at 10 % deformation, measured according to EN 826 (1), shall be $\sigma_{(10\%)} = 0,05 \text{ N/mm}^2$. The batten is loaded perpendicular to the axis by point loads F_b . Further point loads F_s are from the shear load of the roof due to dead and snow load, which are transferred from the screw heads into the battens. The battens or boards, respectively, must have sufficient strength and stiffness.

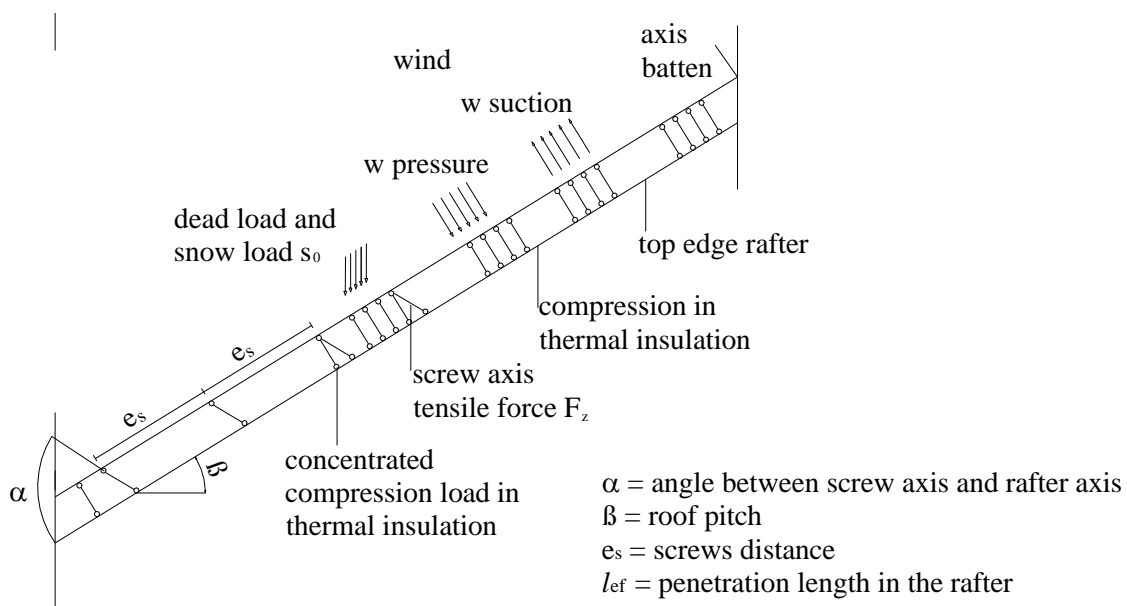
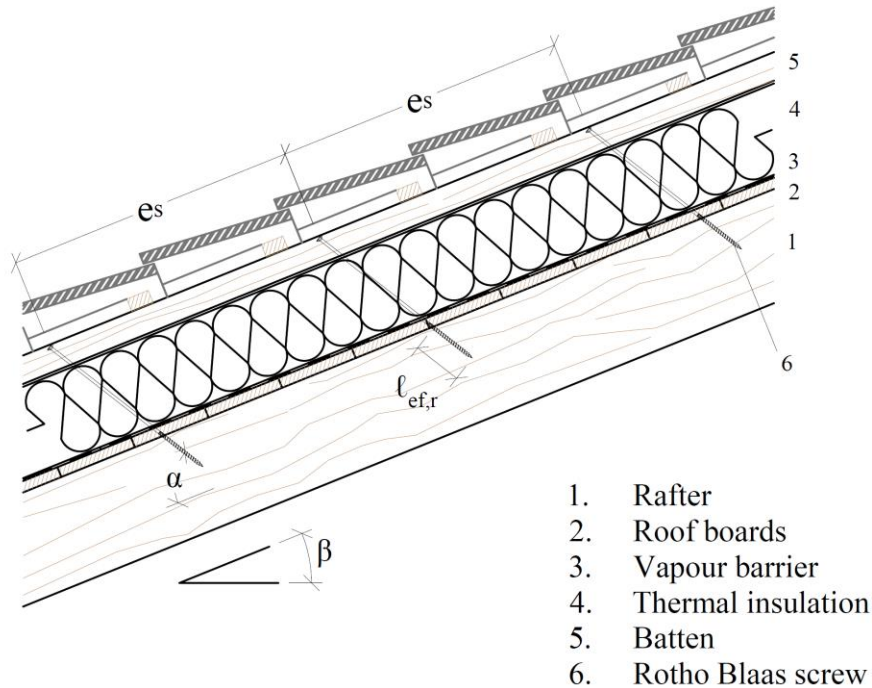

(1) EN 826:1996 Thermal insulating products for building applications - Determination of compression behaviour

Design of the battens

The bending stresses are calculated as:

$$M = \frac{(F_b + F_s) \cdot \ell_{\text{char}}}{4}$$

where

$$\ell_{\text{char}} = \text{characteristic length } \ell_{\text{char}} = \sqrt[4]{\frac{4 \cdot EI}{w_{\text{ef}} \cdot K}}$$

EI = bending stiffness of the batten

K = coefficient of subgrade

w_{ef} = effective width of the thermal insulation material

F_b = point loads perpendicular to the battens

F_s = point loads perpendicular to the battens, load application in the area of the screw heads

The coefficient of subgrade K may be calculated from the modulus of elasticity E_{HI} and the thickness t_{HI} of the thermal insulation material if the effective width w_{ef} of the thermal insulation material under compression is known. Due to the load extension in the thermal insulation material the effective width w_{ef} is greater than the width of the batten or rafter, respectively. For further calculations, the effective width w_{ef} of the thermal insulation material may be determined according to:

$$w_{\text{ef}} = w + t_{\text{HI}} / 2$$

where

w = minimum width of the batten or rafter, respectively

t_{HI} = thickness of the thermal insulation material

$$K = \frac{E_{\text{HI}}}{t_{\text{HI}}}$$

The following condition shall be satisfied:

$$\frac{\sigma_{\text{m,d}}}{f_{\text{m,d}}} = \frac{M_{\text{d}}}{W \cdot f_{\text{m,d}}} \leq 1$$

For the calculation of the section modulus W the net cross section has to be considered.

The shear stresses shall be calculated according to:

$$V = \frac{(F_b + F_s)}{2}$$

The following condition shall be satisfied:

$$\frac{\tau_{\text{d}}}{f_{\text{v,d}}} = \frac{1,5 \cdot V_{\text{d}}}{A \cdot f_{\text{v,d}}} \leq 1$$

For the calculation of the cross section area the net cross section has to be considered.

Design of the thermal insulation material

The compressive stresses in the thermal insulation material shall be calculated according to:

$$\sigma = \frac{1,5 \cdot F_b + F_s}{2 \cdot \ell_{\text{char}} \cdot w}$$

The design value of the compressive stress shall not be greater than 110 % of the compressive stress at 10 % deformation calculated according to EN 826.

Design of the screws

The screws are loaded predominantly axially. The axial tension force in the screw may be calculated from the shear loads of the roof R_s :

$$T_s = \frac{R_s}{\cos \alpha}$$

The load-carrying capacity of axially loaded screws is the minimum design value of the axial withdrawal capacity of the threaded part of the screw, the head pull-through capacity of the screw and the tensile capacity of the screw.

In order to limit the deformation of the screw head for thermal insulation material thicknesses over 200 mm or with compressive strength below 0,12 N/mm², respectively, the axial withdrawal capacity of the screws shall be reduced by the factors k_1 and k_2 :

- for "HBS", "HBSP", "TBS", "KKF", "SCI", "HBSH" screws with partial thread:

$$F_{ax,\alpha,Rd} = \min \left\{ \frac{k_{ax} \cdot f_{ax,d} \cdot d \cdot \ell_{ef} \cdot k_1 \cdot k_2}{k_{\beta}} \cdot \left(\frac{\rho_k}{\rho_a} \right)^{0,8}; f_{head,d} \cdot d_h^2 \cdot \left(\frac{\rho_k}{\rho_a} \right)^{0,8}; f_{tens,d} \right\}$$

- for "DGZ", "VGS", "GWZ", "GWS", "VGZ", "VGZH and VGSH" screws with full thread or double thread:

$$F_{ax,\alpha,Rd} = \min \left\{ \begin{array}{l} \frac{k_{ax} \cdot f_{ax,d} \cdot d \cdot \ell_{ef} \cdot k_1 \cdot k_2}{k_{\beta}} \cdot \left(\frac{\rho_k}{\rho_a} \right)^{0,8} \\ \max \left\{ f_{head,d} \cdot d_h^2; \frac{k_{ax} \cdot f_{ax,d} \cdot d \cdot \ell_{ef,b} \cdot k_1 \cdot k_2}{k_{\beta}} \right\} \cdot \left(\frac{\rho_k}{\rho_a} \right)^{0,8} \\ f_{tens,d} \end{array} \right\}$$

where:

$F_{ax,\alpha,d}$	design value of the load-carrying capacity of axially loaded screws [N]
$f_{ax,d}$	design value of the axial withdrawal parameter of the threaded part of the screw in the rafter or batten [N/mm ²]
d	outer thread diameter of the screw [mm]
ℓ_{ef}	point side penetration length of the threaded part of the screw in the rafter, $\ell_{ef} \geq 40$ mm [mm]
$\ell_{ef,b}$	length of the threaded part in the batten including the head for tensile force [mm]
ρ_k	characteristic density of the wood-based member [kg/m ³]
ρ_a	associated density [kg/m ³]
$f_{head,d}$	design value of the head pull-through parameter of the screw [N/mm ²]
d_h	head diameter [mm]
$f_{tens,d}$	design value of the tensile capacity of the screw [N]
k_1	$\min \{1; 200/t_{HI}\}$
k_2	$\min \{1; \sigma_{10\%}/0,12\}$
t_{HI}	thickness of the thermal insulation material [mm]
$\sigma_{10\%}$	compressive stress of the thermal insulation material under 10 % deformation [N/mm ²]

If k_1 and k_2 are considered, the deflection of the battens does not need to be considered. Alternatively to the battens, panels with a minimum thickness of 20 mm from plywood according to EN 636 or an ETA or national provisions that apply at the installation site, particle board according to EN 312 or an ETA or national provisions that apply at the installation site, oriented strand board according to EN 300 or an ETA or national provisions that apply at the installation site and solid wood panels according to EN 13353 or an ETA or national provisions that apply at the installation site or cross laminated timber according to an ETA may be used.

Thermal insulation on rafters with alternatively inclined “DGZ”, “GWZ”, “GWS”, “VGZ” or “VGS” screws

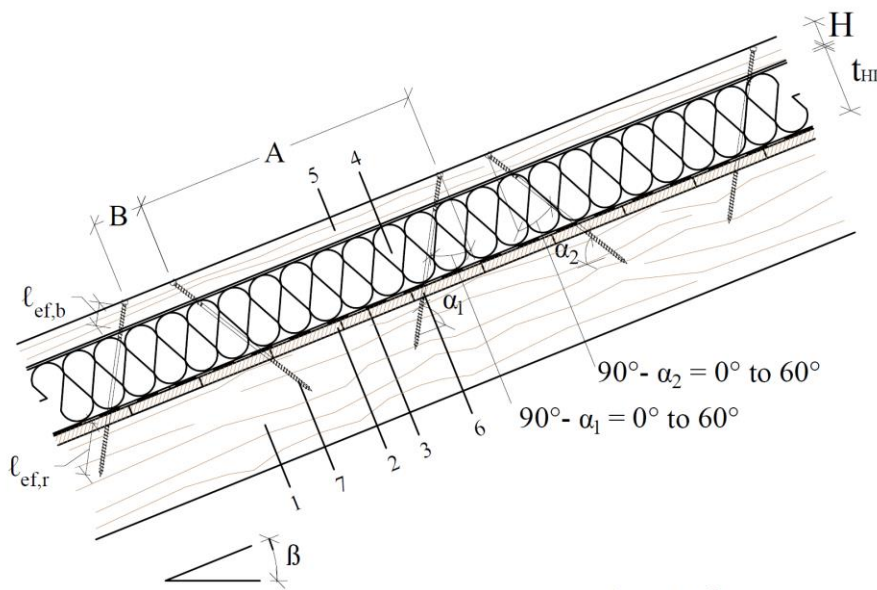

1. Rafter
2. Roof boards
3. Vapour barrier
4. Thermal insulation
5. Batten
6. Rotho Blaas screw loaded in compression
7. Rotho Blaas screw loaded in tension

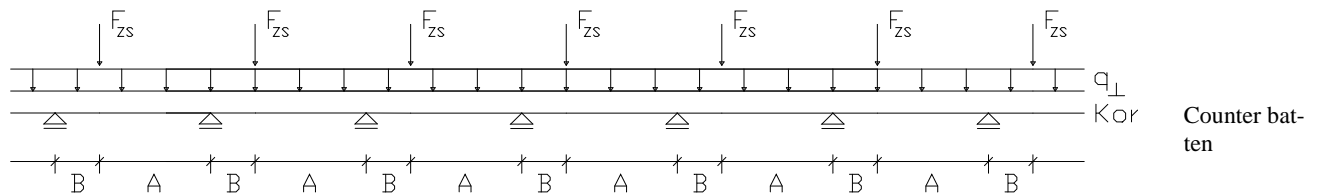

Mechanical model

Depending on the screw spacing and the arrangement of tensile and compressive screws with different inclinations the battens are loaded by significant bending moments. The bending moments are derived based on the following assumptions:

- The tensile and compressive loads in the screws are determined based on equilibrium conditions from the actions parallel and perpendicular to the roof plane. These actions are constant line loads q_{\perp} and q_{\parallel} .
- The screws act as hinged columns supported 10 mm within the batten or rafter, respectively. The effective column length consequently equals the length of the screw between batten and rafter plus 20 mm.
- The batten is considered as a continuous beam with a constant span $\ell = A + B$. The battens or boards, respectively, must have sufficient strength and stiffness. The compressive screws constitute the supports of the continuous beam while the tensile screws transfer concentrated loads perpendicular to the batten axis.

The screws are predominantly loaded in withdrawal or compression, respectively. The screw's normal forces are determined based on the loads parallel and perpendicular to the roof plane:

$$\text{Compressive screw: } F_{c,Ed} = (A + B) \cdot \left(-\frac{q_{\parallel} \cdot \sin \alpha_2 + q_{\perp} \cdot \cos \alpha_2}{\sin(\alpha_1 + \alpha_2)} \right)$$

$$\text{Tensile screw: } F_{t,Ed} = (A + B) \cdot \left(\frac{q_{\parallel} \cdot \sin \alpha_1 - q_{\perp} \cdot \cos \alpha_1}{\sin(\alpha_1 + \alpha_2)} \right)$$

The bending moments in the batten follow from the constant line load q_{\perp} and the load components perpendicular to the batten from the tensile screws. The span of the continuous beam is $(A + B)$. The load component perpendicular to the batten from the tensile screw is:

$$F_{ZS,Ed} = (A + B) \cdot \left(\frac{q_{\parallel} \cdot \sin \alpha_1 \cdot \sin \alpha_2 - q_{\perp} \cdot \cos \alpha_1 \cdot \sin \alpha_2}{\sin(\alpha_1 + \alpha_2)} \right)$$

where:

- q_{\parallel} constant line load parallel to batten
- q_{\perp} constant line load perpendicular to batten
- α_1 angle between compressive screw axis and grain direction
- α_2 angle between tensile screw axis and grain direction

A positive value for F_{ZS} means a load towards the rafter, a negative value a load away from the rafter.

Design of the screws

The load-carrying capacity of the screws shall be calculated as follows:

Screws loaded in tension:

$$F_{ax,\alpha,Rd} = \min \left\{ \frac{k_{ax} \cdot f_{ax,d} \cdot d \cdot \ell_{ef,b}}{k_{\beta}} \cdot \left(\frac{\rho_{b,k}}{\rho_a} \right)^{0.8}; \frac{k_{ax} \cdot f_{ax,d} \cdot d \cdot \ell_{ef,r}}{k_{\beta}} \cdot \left(\frac{\rho_{r,k}}{\rho_a} \right)^{0.8}; f_{tens,d} \right\}$$

Screws loaded in compression:

$$F_{ax,\alpha,Rd} = \min \left\{ \frac{k_{ax} \cdot f_{ax,d} \cdot d \cdot \ell_{ef,b}}{k_{\beta}} \cdot \left(\frac{\rho_{b,k}}{\rho_a} \right)^{0.8}; \frac{k_{ax} \cdot f_{ax,d} \cdot d \cdot \ell_{ef,r}}{k_{\beta}} \cdot \left(\frac{\rho_{r,k}}{\rho_a} \right)^{0.8}; \frac{\kappa_c \cdot N_{pl,k}}{\gamma_{M1}} \right\}$$

where:

- $F_{ax,\alpha,Rd}$ design value of the load-carrying capacity of the screw [N]
- $f_{ax,d}$ design value of the axial withdrawal parameter of the threaded part of the screw in the rafter or batten [N/mm²]
- d outer thread diameter of the screw [mm]
- $\ell_{ef,b}$ penetration length of the threaded part of the screw in the batten including the head for tensile and excluding the head for compressive force [mm]
- $\ell_{ef,r}$ penetration length of the threaded part of the screw in the rafter, $\ell_{ef} \geq 40$ mm [mm]
- $\rho_{b,k}$ characteristic density of the batten [kg/m³]
- $\rho_{r,k}$ characteristic density of the rafter [kg/m³]
- α angle α_1 or α_2 between screw axis and grain direction, $30^{\circ} \leq \alpha_1 \leq 90^{\circ}$, $30^{\circ} \leq \alpha_2 \leq 90^{\circ}$
- $f_{tens,d}$ design value of the tensile capacity of the screw [N]
- γ_{M1}, γ_{M2} partial factor according to EN 1993 or to the particular national annex
- $\kappa_c \cdot N_{pl,k}$ buckling capacity of the screw [N]

Buckling capacity of the screw

Free screw length [mm]	"DGZ"		"GWZ", "GWS", "VGZ" or "VGS"				"VGZH" or "VGSH"	
	7 mm	9 mm	7 mm	9 mm	11 mm	13 mm	6 mm	8 mm
	$\kappa_c \cdot N_{pl,k}$ [kN]	$\kappa_c \cdot N_{pl,k}$ [kN]	$\kappa_c \cdot N_{pl,k}$ [kN]	$\kappa_c \cdot N_{pl,k}$ [kN]	$\kappa_c \cdot N_{pl,k}$ [kN]	$\kappa_c \cdot N_{pl,k}$ [kN]	$\kappa_c \cdot N_{pl,k}$ [kN]	$\kappa_c \cdot N_{pl,k}$ [kN]
≤ 100	3,52	9,23	2,57	6,49	9,75	19,2	2,37	6,49
120	2,68	7,15	1,95	4,99	7,57	15,2	1,79	4,99
140	2,10	5,68	1,53	3,95	6,02	12,3	1,41	3,95
160	1,70	4,61	1,23	3,19	4,89	10,1	1,13	3,19
180	1,40	3,82	1,01	2,63	4,05	8,38	0,93	2,63
200	1,17	3,21	0,84	2,22	3,40	7,08		2,22
220	0,99	2,74	0,71	1,88	2,91	6,05		1,88
240	0,85	2,36	0,61	1,62	2,50	5,23		1,62
260	0,74	2,05	0,53	1,41	2,18	4,58		
280	0,65	1,80	0,47	1,23	1,91	4,03		
300	0,57	1,59	0,41	1,09	1,69	3,57		
320		1,42		0,97	1,51	3,19		
340		1,27		0,87	1,35	2,86		
360		1,15		0,79	1,22	2,58		
380		1,04		0,71	1,10	2,34		
400		0,95		0,65	1,01	2,14		
420					0,92	1,95		
440					0,84	1,80		
460					0,78	1,65		

where

free screw length = $t_{HI} / \sin \alpha$ [mm] ($\alpha = \alpha_1$ or α_2)

Annex E

Shear reinforcement

Unless specified otherwise in national provisions that apply at the installation site, the shear stress in reinforced areas of timber members with a stress component parallel to the grain shall fulfil the following condition:

$$\tau_d \leq \frac{f_{v,d} \cdot k_\tau}{\eta_H}$$

Where: τ_d is the design shear stress disregarding the reinforcement [N/mm²];

$f_{v,d}$ is the design shear strength [N/mm²];

$$k_\tau = 1 - 0,46 \cdot \sigma_{90,d} - 0,052 \cdot \sigma_{90,d}^2$$

$\sigma_{90,d}$ is the design stress perpendicular to the grain (negative value for compression) [N/mm²];

$$\sigma_{90,d} = \frac{F_{ax,d}}{\sqrt{2} \cdot b \cdot a_1}$$

$$F_{ax,d} = \frac{\sqrt{2} \cdot (1 - \eta_H) \cdot V_d \cdot a_1}{h}$$

$$\eta_H = \frac{G \cdot b}{G \cdot b + \frac{1}{2 \cdot \sqrt{2} \left(\frac{6}{\pi \cdot d \cdot h \cdot k_{ax}} + \frac{a_1}{EA_S} \right)}}$$

V_d is the design shear force [N];

G is the shear modulus of the timber member, $G = 650$ N/mm²,

b is the width of the timber member in mm,

d is the outer thread diameter in mm,

h is the depth of the timber member in mm,

k_{ax} is the connection stiffness between screw or rod and timber member in N/mm³,

$k_{ax} = 5$ N/mm³ for Rotho Blaas RTR rods $d = 16$ mm,

$k_{ax} = 12,5$ N/mm³ for Rotho Blaas VGZ screws $d = 9$ mm,

a_1 is the spacing parallel to the grain of the screws or rods arranged in one row in mm,

EA_S is the axial stiffness of one rod or screw [N],

$$EA_S = \frac{E \cdot \pi \cdot d_1^2}{4} = 165.000 d_1^2$$

d_1 is the inner thread diameter of the rod or screw in mm.

The axial capacity of a threaded screw or rod shall fulfil the following condition:

$$\frac{F_{ax,d}}{F_{ax,Rd}} \leq 1$$

Where:

$F_{ax,Rd}$ Minimum of the design values of the withdrawal capacity and the tensile capacity of the reinforcing rods or screws [N]. The effective penetration length is 50 % of the threaded length.

A minimum of four screws or rods in a row are required in each reinforced area. Outside reinforced areas (shaded area in Figure E.1) the shear design shall fulfil the conditions for unreinforced members.

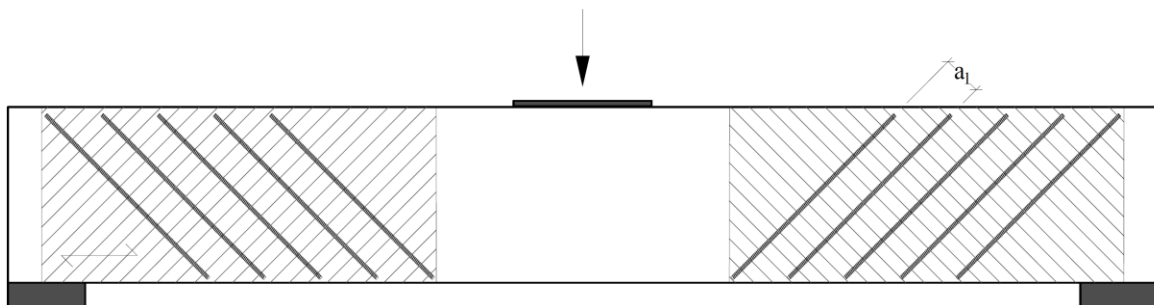

Figure E.1: Timber member with shear reinforcement; shaded areas: reinforced areas

Annex F

Tensile reinforcement perpendicular to grain

Timber members loaded by a connection force perpendicular to the grain

Unless specified otherwise in national provisions that apply at the installation site, the axial capacity of a reinforcement of a timber member loaded by a connection force perpendicular to the grain shall fulfil the following condition:

$$\frac{[1 - 3 \cdot \alpha^2 + 2 \cdot \alpha^3] \cdot F_{90,d}}{F_{ax,Rd}} \leq 1$$

Where

$F_{90,d}$ Design value of the force component perpendicular to the grain in N,

$\alpha = a/h$

h = member depth in mm

$F_{ax,Rd}$ Minimum of the design values of the withdrawal capacity and the tensile capacity of the reinforcing screws or threaded rods where ℓ_{ef} is the smaller value of the penetration depth below or above the potential crack in N

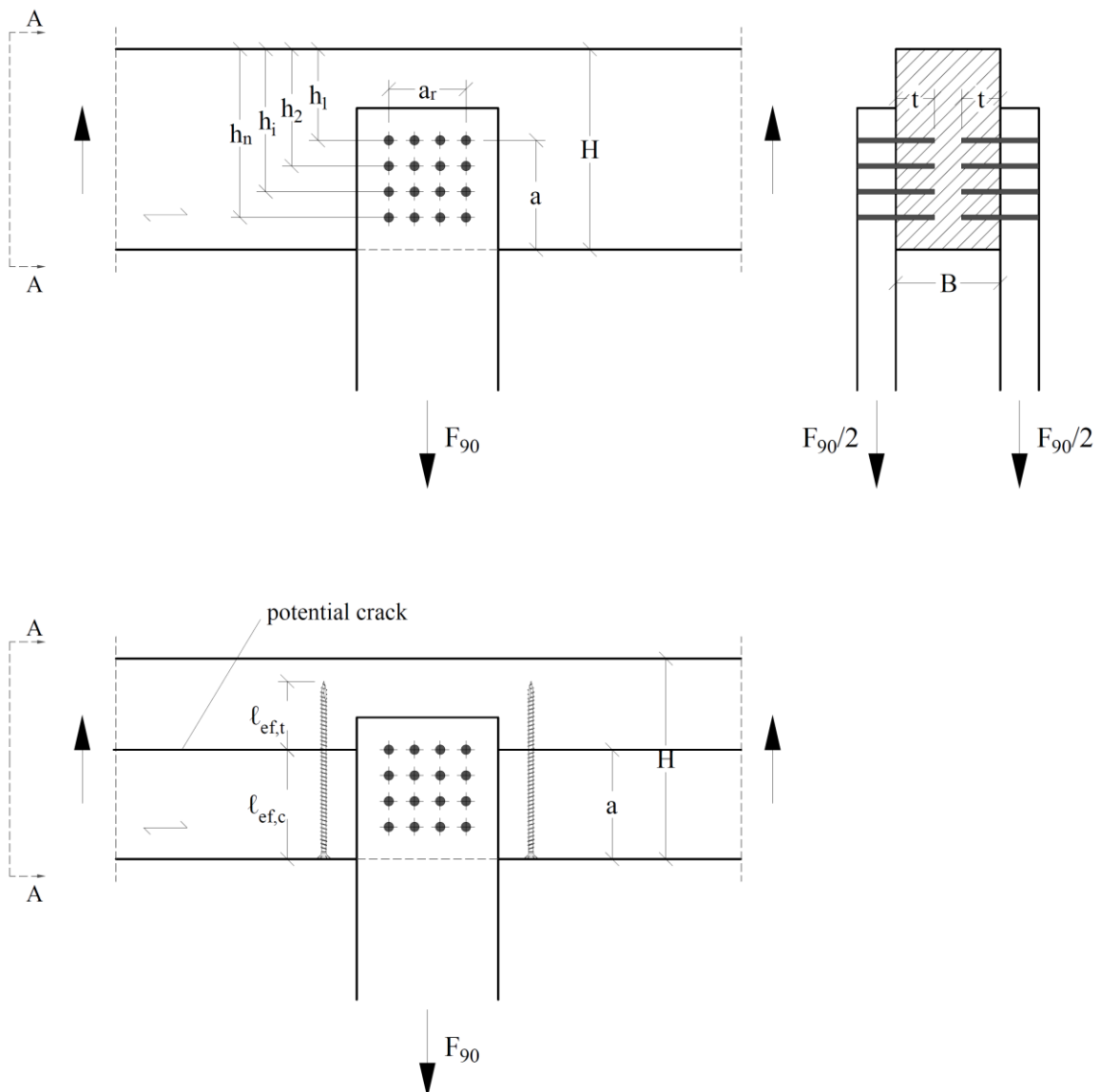

Notched beam supports

Unless specified otherwise in national provisions that apply at the installation site, the axial capacity of a reinforcement of a notched beam support shall fulfil the following condition:

$$\frac{1,3 \cdot V_d \cdot [3 \cdot (1 - \alpha)^2 - 2 \cdot (1 - \alpha)^3]}{F_{ax,Rd}} \leq 1$$

Where

V_d Design value of the shear force in N,

$\alpha = h/h_e$

h = member depth in mm

$F_{ax,Rd}$ Minimum of the design values of the withdrawal capacity and the tensile capacity of the reinforcing screws or threaded rods where ℓ_{ef} is the smaller value of the penetration depth below or above the potential crack in N

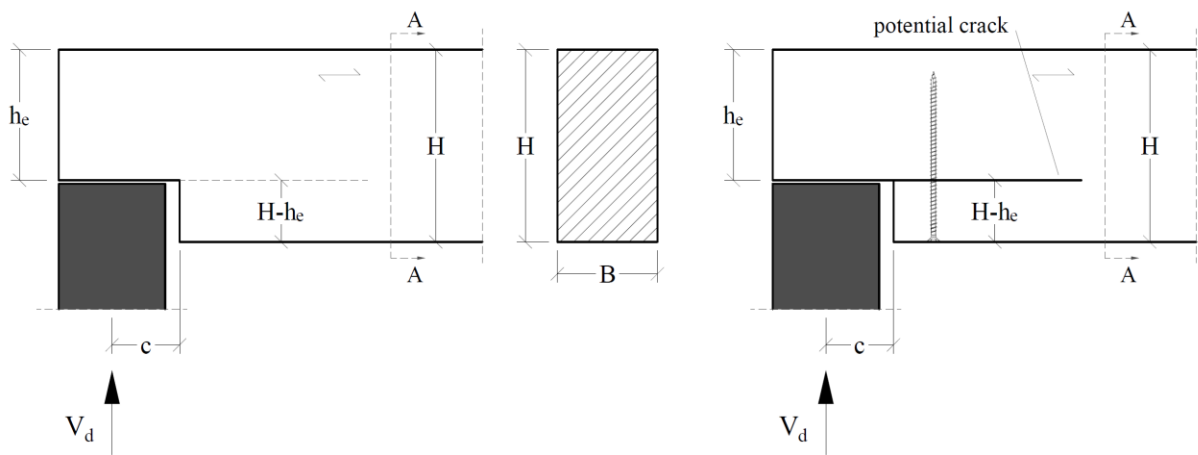

Beams with holes

Unless specified otherwise in national provisions that apply at the installation site, the axial capacity of a reinforcement of a hole in a beam shall fulfil the following condition:

$$\frac{F_{t,V,d} + F_{t,M,d}}{F_{ax,Rd}} \leq 1$$

Where

$F_{t,V,d}$ Design value of the force perpendicular to the grain due to shear force in N:

$$F_{t,V,d} = \frac{V_d \cdot h_d}{4 \cdot h} \cdot \left[3 - \frac{h_d^2}{h^2} \right]$$

V_d Design value of the member shear force at the hole end in N,

h = member depth in mm

h_d = hole depth for rectangular holes in mm

h_d = 70 % of hole diameter for circular holes in mm

$F_{t,M,d}$ Design value of the force perpendicular to the grain due to bending moment in N:

$$F_{t,M,d} = 0,008 \cdot \frac{M_d}{h_r}$$

M_d Design value of the member bending moment at the hole end in Nm,

h_r = min (h_{ro} ; h_{ru}) for rectangular holes in mm

h_r = min (h_{ro} ; h_{ru}) + 0,15· h_d for circular holes in mm

$F_{ax,Rd}$ Minimum of the design values of the withdrawal capacity and the tensile capacity of the reinforcing screws or threaded rods where l_{ef} is the smaller value of the penetration depth below or above the potential crack in N.

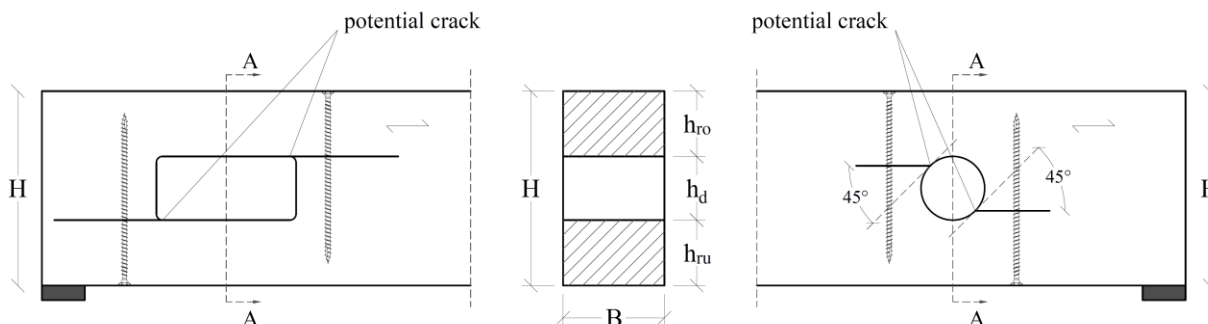

Annex G Definition of angles in LVL

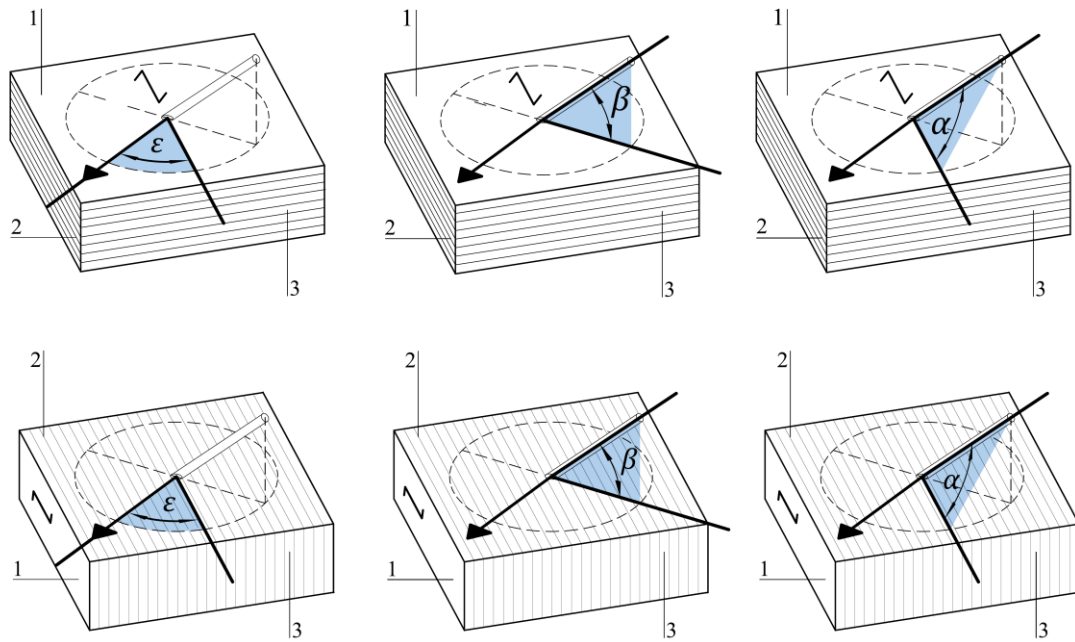

Note. Drawing is copyright Rotho Blaas

1. LVL's wide side
2. LVL's narrow side
3. LVL's face side (lateral side consisting primarily of end grain)

ε : angle between load and grain direction ($0^\circ \leq \varepsilon \leq 90^\circ$)

α : angle between screw axis and grain direction

β : angle between screw axis and the LVL's wide side ($0^\circ \leq \beta \leq 90^\circ$)